

TACIT 
ALWAYS ON COURSE



GOLF COURSE EQUIPMENT



FOREWORD

Tacit is a family owned and run business. Our key activities are invested in the design, UK manufacture and worldwide distribution of bespoke golf course equipment.

Tacit's unique vision is to be a growing, caring organisation, striving to achieve better results year-on-year. We achieve this by blending investment programmes in all business activities, using modern equipment and systems with dedicated, experienced and skilled people in all areas.

My vision is to be universally recognised as the market leader in the management and execution of all our activities by using:-

- Our unique balance of commercial and technical expertise.
- Our proven track record of excellent quality and service.
- Our innovative delivery of value enhancing solutions to meet all our customers' needs.

By working in partnership with superintendents and suppliers, we will continue to achieve world-class leadership in quality, engineering, design, delivery, service and management of all products.

We look forward to helping you become the best you can be.

Richard Webb
Chairman



CONTENTS

FEATURED PRODUCTS 4-5

TEE AREA

Tee Markers	6-7
Information Signs	8-9
Bins and Brushes	10-11
Ball Washers	12-13
Divot / Pitch Repair	14-15

ON COURSE

Fairway Info Safety	16-17
Player Rakes	18-19
Traffic Control	20-21
Signs	22-25

GREEN AREA

Logo Flags	26-28
Standard Flags	29-30
Florida Keys & Winter Flag Clips	31-32
Standard Pins	33-34
Tournament Pins	35-36
Hickory	37-38
Hole Cups	39-42
Hole Cutting	43-45
Putting Green	46-47

MAINTENANCE

Rakes	48-50
Fine Turf Tools	51-54
Water/Dew Removal	55-56

YEAR PLANNER 57-58



SHOLE HAMMER HOLECUTTER
Page 44

59 Moat Farm Drive
Hillmorton
Rugby
Warwickshire
CV21 4HQ
England

www.tacitgolf.com
Email: sales@tacitgolf.com
TEL: +44 (0)1788 568818

NANO GAUGE
0925NANO

SEE PAGE 46



FLORIDA KEY
0898FK

SEE PAGE 33



WINTER FLAG CLIP
0898FS

SEE PAGE 32



FEATURED PRODUCTS

SHOLE HAMMER HOLECUTTER

The Tacit Shole Hammercutter cuts an exact 108mm hole every time with an integral hammer action. With an upright operation, it is easy on the back with a unique effortless core extraction system and the whole unit weighs less than 10kg! The bullseye spirit level makes sure every hole is cut level. It also comes with easy interchangeable compression / non-compression blades with an optional adjustable depth gauge.

REJUVENATOR

Restores ball marks, animal tracks and indentations in the green to the original putting surface level. No tamping needed, tailored for effective ergonomic use. Virtually no maintenance as stainless steel tines give your green the perfect finish.

REJOINER

Unique interlocking turf repair tool that allows damaged turf on the green to be repaired quickly and easily. The distinctive shape encourages the turf to knit in much quicker than other straight sided designs.

FLORIDA KEY

An ingenious way of rapidly changing the flag without the hassle of fiddly nuts; saves time and has no moving parts, hence nothing to break. Also screws onto an existing top ferrule.

The Florida key will reposition itself automatically in the wind yet requires just two twists to remove.

WINTER FLAG CLIP

A simple but effective way of shortening the length of the flag therefore reducing wear on the flag, making the flag pin easier to handle in windy conditions.

NANO GAUGE

Competition tested, this Nano gauge sets the hole and cup instantly to R & A recommended size and depth. Its size allows it to be easily carried in a pocket for instant use, even while the competition is in play.

“The Rejoinder is great and easy to use. The shape is especially useful as it locks all edges”

Jon Allen, Course Manager
Northampton Golf Club

FEATURED PRODUCTS

**SHOLE HAMMER
HOLECUTTER**
1013BCOM



SEE PAGE 44

REJUVENATOR
6040



SEE PAGE 55

REJOINER
0919J



SEE PAGE 54

Example of the
Rejoinder pattern

TEE AREA

TEE MARKERS

TUFFTEX TEE MARKERS

Great value and performance in one; Tacit's Tufftex Tee Markers offer a durable and vandal resistant marker at an exceptional price. Tacit Tufftex's come complete with a stainless steel spike and are made to withstand tough treatment. To further frustrate the vandals, Tacit Tufftex's also float.

TUFFTEX TRADITIONAL TEE MARKERS

Providing the same value for money as the Tufftex Tee Marker and with the same rugged construction, the "Traditional" has the added bonus of being able to be customised either with a number, corporate/club logo.

BESPOKE TEE MARKERS

Can be manufactured to any 2D design, laser cut to shape and then decaled to provide intricate detail as required. The design is only limited by your imagination. Let our Graphics department help you create a lasting impression on every tee.

PEAR SHAPED TEE MARKERS

Traditionally shaped, colour impregnated markers that are almost indestructible. The stainless steel spike means these markers will last indefinitely. The tee marker floats and is also instilled with UV stabiliser to inhibit the sun rays and keep the marker brighter for longer.

BROKEN TEE CADDY

For the more discerning golf course; a Tee Marker with a colour impregnated top combined to make a subtle but visible impression. Made from polypropylene with a stainless steel spike, these markers can withstand the harshest conditions.

WOODLAND TEE MARKER

An economical version of the Augusta, this Woodland Tee Marker is perfectly suited to parkland environments. Made with a stainless steel spike, these markers add class to any course. Corporate images are easily applied thanks to Tacit's unique interchangeable face plate and all at an affordable price.

AUGUSTA LOG TEE MARKER

A revolutionary slant on a traditional classic will add that touch of class to any tee. Made from recycled polymers, these wood effect logs never need to be painted, varnished or treated and will constantly look as good as the day they were purchased. Interchangeable end caps mean colours can be changed or refurbished in an instant and can be easily maintained. Whilst the decal system allows the corporate image to stretch throughout the course, the markers are held firmly in place by their stainless steel pins.



“ The longevity and quality finish of the Tacit Tee Markers give my tees the look my members demand

Alec Macindoe, Course Manager
Newbury & Crookham Golf Club



PEAR SHAPED TEE MARKERS

0011



0012



0029



0030



0031



0032



TUFFTEX TEE MARKERS

0008



0009



0025



0026



0027



0028



TUFFTEX TRADITIONAL TEE MARKERS

0025L



0026B



0027L



AUGUSTA LOG TEE MARKERS

0016C



0016C



0016G



WOODLAND TEE MARKERS

0021L



0022L



0023L



BROKEN TEE CADDY

1071W



1071Y



1071R



0059



WALL MOUNTED

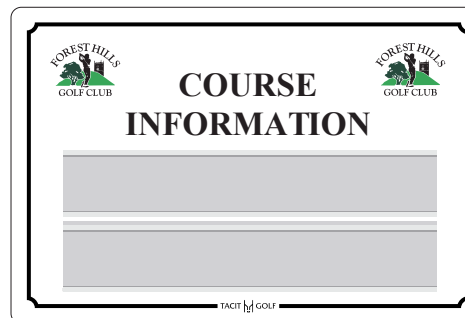

TEE AREA INFORMATION SIGNS

TACIT EVENT BOARD

This is the definitive event board made from a high grade aluminium. It can be fixed to a wall or posts. Daily events are slotted into place whilst today notices can be conveniently written or removed on a dry wipe board. Our team of designers will include your club or corporate colours to create an event board that looks attractive both outside and in the clubhouse.

FREE STANDING CLOCK INFORMATION BOARD

Sandwich board construction allows this board to be placed on the practice ground or by the pro shop. The outdoor clock is impervious to rain and the dry wipe area underneath allows daily messages to be conveyed. The back of the sign can also be utilised to give course or sales information.

“The sign department produces consistent quality, which provides us with a high standard across the course”

Paul Sharp, Course Manager
Peterculter Golf Club Aberdeen



NAIRN DUNBAR GOLF CLUB

ALL VISITORS REPORT TO PRO - SHOP
COURSE INFORMATION

COURSE CLOSED	<p>HEALTH & SAFETY</p> <ul style="list-style-type: none"> ▶ Please be aware of danger to vehicles and pedestrians on Houston Road when playing holes 2, 5, 13, 14 & 17. ▶ During wet and/or freezing weather underfoot conditions may be hazardous ▶ GREENKEEPERS HAVE PRIORITY WHEN WORKING ON THE COURSE
COURSE CLOSED	
PREFERRED LIES	
TEMPORARY GREENS	
"THROUGH THE GREEN" - RELIEF PERMITTED <small>(Rule 21-1b (i))</small>	
PLEASE FOLLOW DESIGNATED TRAFFIC ROUTES	
1st and 3rd HOLES - ACCESS TO GARDENS TO RETRIEVE BALL STRICTLY PROHIBITED	
FLAGS / PIN POSITIONS (approx) <small>WHITE = FRONT; YELLOW = MIDDLE; RED = BACK</small>	
PLEASE REPAIR ALL PITCHMARKS!	
PLEASE REPAIR ALL DIVOTS!	
PLEASE DEPOSIT RUBBISH IN LITTER BINS	

SUPPLEMENTARY / DAILY INFORMATION



/whiteboard for marker pen use/

TACITTM Tel: +44 (0) 1788 568818



WELCOME TO HOCKLEY GOLF CLUB

COLOURS OF FLAGS ON GREENS INDICATE POSITION OF PINS AS FOLLOWS

 FRONT
 MIDDLE
 BACK



DID YOU KNOW?

A RECENT UNITED STATES P.G.A. TEST HAS SHOWN THAT A PITCHMARK LEFT UNREPAIRED FOR 10 MINUTES OR LONGER TAKES 15 DAYS TO RECOVER WHEREAS A PITCHMARK REPAIRED WITHIN 5 MINUTES RECOVERS COMPLETELY WITHIN 24 HOURS.

NO PLAY BEFORE 07:15AM

COURSE OPEN

CARRY ONLY

SPRAYING IN PROGRESS

NO BUGGIES

- WE RESERVE THE RIGHT TO PAIR PLAYERS ON BUSY DAYS.
- IF YOU CANNOT KEEP YOUR POSITION ON THE COURSE FOR WHATEVER REASON, AND ARE DELAYING THE GROUP BEHIND, THEN YOU ARE TO INVITE THE GROUP BEHIND TO PLAY THROUGH. SLOW PLAY IN GENERAL PLAY, ROLL UPS, CLUB COMPETITIONS, TEAM MATCHES OR KNOCKOUT COMPETITIONS IS NOT A REASON FOR **NOT** ALLOWING FASTER PLAYERS THROUGH. IF YOU HAVE LOST A HOLE ON THE GROUP IN FRONT OR DELAYING PLAYERS BEHIND, YOU **MUST** ALLOW THEM TO PLAY THROUGH.
- PLEASE REPAIR DIVOTS AND PITCH MARKS.

- THE USUAL DRESS CODE APPLIES
- JEANS, T-SHIRTS WITHOUT COLLARS AND TRACK SUITS ARE NOT ACCEPTABLE.
- GOLF SHOES MUST BE WORN.
- ALL PLAYERS MUST HAVE SIGNED INTO THE PRO SHOP PRIOR TO COMMENCING PLAY.
- ALL PLAYERS ARE RESPONSIBLE FOR THEIR ACTIONS ON THE GOLF COURSE.

GREENKEEPERS HAVE PRIORITY OF THE COURSE, PLEASE BE PATIENT.

www.hockleygolfclub.com

TACITTM Tel: +44 (0) 1788 568818



COURSE INFORMATION



TEE#1	366 YDS
TEE#2	366 YDS
TEE#3	366 YDS
TEE#4	366 YDS
TEE#5	366 YDS
TEE#6	366 YDS

TACITTM GOLF

TEE UNIT
0090



U-BOOT SHOE CLEANER
0085



SET 3
0087

SET 6
0088

SET 9
0086



DEBRIS BRUSH
0089



SCRAPER
0085BS



TEE AREA BINS AND BRUSHES

ULTRA BIN S1

The first of our Ultra Bin Series is the standard Ultra Bin. All the Ultra Bin Series feature a polyethylene body shell that will not rust or dent and incorporate a galvanised steel liner that is easy to remove and clean. The speckled green finish of the Ultra Bin Series blend seamlessly into your course environment. The S1 model has an open removable top and both models can be customised with text or course logos.

ULTRA BIN S2

This latest addition to our Ultra Bin Series carries all the standard features, but has a 22% larger capacity than the Ultra Bin S1 and features a locking lid. The Ultra Bin S2 is ideal for windy spots and heavy traffic areas.

LITTER BASKET

Our entry-level plastic-coated wire litter basket is a light weight basket with a removable bottom tray for hygienic cleaning and emptying.

BALMORAL BIN

The Balmoral (Rhino) Bin gives a hardwood traditional finish to a golf course classic. Manufactured to exacting standards the bin is obviously built by time served craftsmen. With an easy to remove lid and a galvanised liner, rubbish collection becomes easy and efficient.

SANDRINGHAM BIN

A modern twist to the Balmoral Bin, similar looking but with recycled wood panelling around the outside of the unit making it a much more environmentally friendly bin finished again to Tacit's exacting standards.

U-BOOT SHOE CLEANER SERIES

Recent tests have shown the U-Boot Shoe Cleaner to be the number one choice for cleaning soft spikes. Its bristles being particularly suited to removing debris that prevents the correct function of soft spikes. The slatted design of the U-Boot Shoe Cleaner allows debris to fall away from the brushes, while the positioning of the brushes cleans both the soles and sides of your shoes simultaneously. The U-Boot Shoe Cleaner allows the user to lean on a handrail while brushing shoes.

SCRAPER

A great addition to the u-boot shoe cleaner, the scraper allows ingrained mud to be moved from the bottom of golf shoes with ease.

TEE UNIT

Our other style U-Boot Shoe Cleaner is the Tee Unit. Its low profile means it is the perfect shoe cleaning unit that can be installed near a tee. It is low and unobtrusive to the eye and will blend effortlessly into the course.

DEBRIS BRUSH

A hardwood construction with a brass scraper gives your shoe cleaner that added class.

ULTRA BINS

S1
S1 0062



S2
S2 0080



LITTER BASKET
0065



LITTER BASKET INSERT



BALMORAL
1069



SANDRINGHAM
1070



RECYCLING STATION



RECYCLING BIN





PADDLE ASSEMBLY
0074

BALL WASHER BRUSHES
0075

DRAIN PLUG
0076



TOWEL CLIP
0079



MOVE CONCENTRATED GOLF BALL CLEANER
0084M



ECONOMY BALL WASHER
0070



TEE AREA BALL WASHERS

CLASSIC BALL WASHER

Tacit's traditional classic that lives up to our reputation for quality, longevity and ease of use. Investment cast aluminium body with an epoxy powder coating. All fittings are marine stainless steel. The spiral action plunger adds traditional values whilst the replacement plunger knob and large tamper resistant drain plug allow for ease of maintenance.

CLASSIC BALL WASHER PARTS

Towel Green
Towel Blue with Logo
Agitator Assembly
Brush Assembly
White Gasket
Cover Screws
Drain Plug
Drain Plug Gasket
Ball Washer Towel Hooks
Ball Washer Litter Bin 4 kilos / 32 litres
(including brackets)
Mounting Pipe 34"
Mounting Pipe 46"
Base Tacit Green
Base Tacit Black
Base Tacit Red

REPLACEMENT PARTS

A complete range of spare parts are available for the Tacit Economy Ball Washer system.

Brass Drain Plug
Paddle Assembly
Brushes (pair)
Towel Green
Towel Green with Logo
Towel Blue
Towel Blue with Logo
Towel Clip

Economy Ball Washer
Ball Washer Post

ECONOMY BALL WASHER

A ball washer that combines quality and reliability at an affordable price. Made from super tough polypropylene; the case stays practically maintenance free whilst a large sump and drain plug allows for easy washouts. All internal parts are impervious to water (no wooden brushes to rot and smell!) and can be replaced in seconds. A ball washer that cleans golf balls better than ball washers that cost twice the price.

MOVE CONCENTRATED GOLF BALL CLEANER

Move is a sequoia pine fragranced biodegradable golf ball washer liquid conveniently bottled in handy 1 litre bottles.

- Highly concentrated
- Fragrant
- Moves mud with ease

“The Tacit Classic Powder Coated Ballwasher is a very strong ballwasher, nicely presented with a logo, golfers like them and greenkeepers find them easy to clean”

Martin Browne, Course Superintendent
Skerries Golf Club

BALL WASHERS



MOUNTING PIPE
3022



LOGO DIVOT BAGS
4970LOGO



DIVOT BAG TREE
0178



0179S



TEE AREA **DIVOT / PITCH REPAIR**

REJUVENATOR

Restores ball marks, animal tracks and indentations in the green to the original putting surface level. No tamping needed, tailored for effective ergonomic use. Virtually no maintenance, stainless steel tines give your green the perfect finish.

DIVOT BOX

Tacit's Divot Box promotes instant repair on the tee by providing the materials required to easily fill and repair divots. Moulded from super tough polyethylene and designed with a lid to prevent water from entering, the Tacit Divot Box is unquestionably superior to any other divot box on the market. The box has an 18ltr capacity and can be sighted at ground level or on a stand, combined with the ability to attach a sponsor plate to the lid this truly is the ideal companion to any tee.

Other colours available on request.

DIVOT BAG TREE

The ideal way to get members involved in course maintenance. Placed at the beginning of the hole and regularly rotated to cover all 18 holes the members can easily divot fill one hole at a time without having the inconvenience of carrying sand and seed for 18 holes. A proven course enhancer and money saver.

LOGO DIVOT BAG

Add a touch of class and security by putting your club logo on the divot bag. Any wording or logo can be applied and can even be individually numbered.

“The Rejuvenator works well all year, on anything from pitchmarks to deer damage”

Martin Scothern, Head Greenkeeper
Wollaton Park Golf Club

REJUVENATOR
6040



DIVOT BOX SPECKLED
0061



DIVOT BOX GREEN
0060



SCOOP
0064



DIVOT BOX LOGO
0053



DIVOT BOX ETCHED LOGO



KLAXON HORN
0091



BALL SCOOP
0091



6" BELL
0174



Bracket
0176



9" BELL
0175

Lanyard
0177

LIFE BUOY RING
0170



FLOATING ROPE
0171



ON COURSE FAIRWAY INFO / SAFETY

RECYCLED LUMBER HAZARD POSTS

Out Of Bounds
Lateral Water Hazard
Water Hazard
Green

DISTANCE MARKER POSTS

Blue Post
Green Post
Blue Spiked Post
Green Spiked Post

Ground Socket Tool - Rectangular
Ground Socket - Rectangular

DISTANCE MARKER DISCS

White Distance Marker Disc
Yellow Distance Marker Disc
Blue Distance Marker Disc
Red Distance Marker Disc

KLAXON HORN SYSTEM

Simple and easy to install, this cost effective air horn gives immediate and effective warning. Used for warning players of potential lightning strikes. Audible over the entire course in most situations. No power supply required.

BALL SCOOP

A 3m reach and lightweight aluminium shaft allows the scoop to be used easily by all your members and green staff alike. With a cast aluminium head and basket, the collection of balls becomes easy.

BELL AND BRACKET

Tacit's Bells and Brackets are cast at a foundry specialising in the production of high quality bespoke bells. Only the finest high grade bronze is used to provide a bell of superior shape and tone.

LIFE BUOY RING AND ROPE

Tacit's Life Buoy conforms to all recognised Health and Safety guidelines for use at inland open water sites. Ensure the people using your course are covered by the availability of a well marked and positioned life buoy and floating rope.

“A first class product and service. Excellent attention to detail and leadtimes”

Stuart Donald, Course Manager
Knebworth Golf course

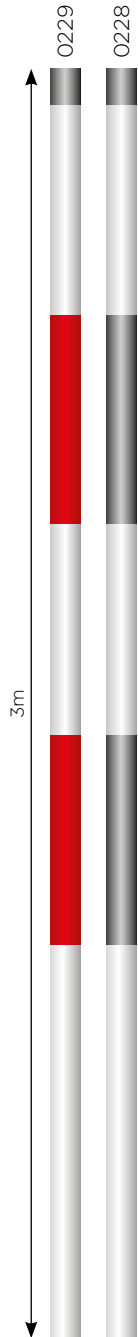

FAIRWAY INDICATOR POSTS

Tacit's 3m Fairway Indicator Posts are available in black and white stripe or red and white stripe made with an extra thick wall diameter to resist ball impact whilst staying light enough for members to remove them prior to playing their shot. Tacit's Fairway Indicator Posts are provided with a ground socket to make installation and replacement easy whilst also ensuring the post remains upright at all times.

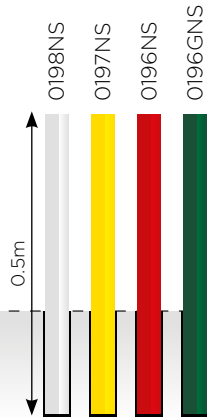

RECYCLED GROUND SOCKET LUMBER HAZARD POSTS

Made from self coloured reconstituted plastic; these hazard posts will never need painting or refurbishing. Simply speaking they will last a lifetime and you're helping the environment!

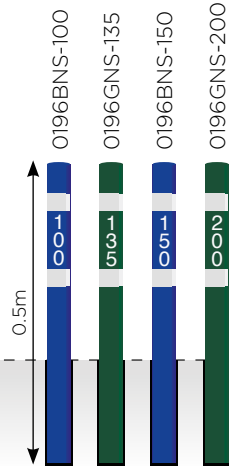

RECYCLED GROUND SOCKET DISTANCE MARKER POSTS



RECYCLED SPIKED LUMBER HAZARD POSTS

Self coloured reconstituted plastic with an integral stainless steel spike means these hazard posts will never need painting or refurbishing.

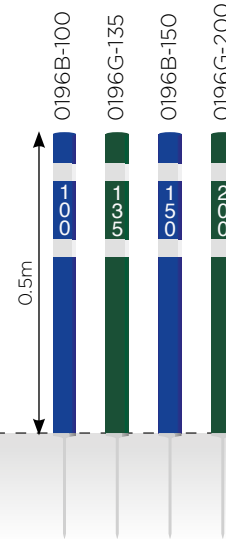

RECYCLED SPIKED DISTANCE MARKER POSTS



ALUMINIUM CAST DISTANCE MARKER DISCS

A perfect low profile Distance Marker Disc. When fitted it provides an extremely visible reference for the various distances.

All colour and number variation options available.

GROUND SOCKET SYSTEM

By using Tacit's Ground Socket System you save time and money by eliminating the need to dig holes and mix concrete. Simply drive the ground socket into the turf with Tacit's solid steel ground socket tool to leave the socket flush with the soil.



“The Standeasy was the original handle-off-the-ground players rake, that has proven its quality over time”

David Goodchild, Head Greenkeeper
Ellesborough Golf Club

STAND EASY RAKE



STAND FOR ACCUFORM RAKE
6037STAND



ON COURSE PLAYERS RAKES

SPARROW BUNKER RAKES

Undoubtedly, the finest players' bunker rake on the market. Available in 3 colours; white, green or black and fitted as standard with a plastic coated aluminium shaft. The Sparrow Rake is at home either in or out of the bunker.

SPARROW BUNKER RAKE GRIP

RAKE DECAL

A simple reminder to place rakes in or out of the bunker.

STANDEASY RAKE

Combining Tacit's Sparrow Rake with a stand helps keep the handle dry. Tacit have consistently provided top class golf clubs with a rake to match their members' exacting standards. Available in white, green or black.

STAND FOR ACCUFORM RAKE

PLAYERS RAKES



0133



0132



0134

SPARROW RAKE



RAKE DECALS

0130

Rugby Golf Club

PLEASE PLACE IN THE BUNKER

0131

Rugby Golf Club

PLEASE PLACE OUTSIDE BUNKER

FOLDABLE RAKE



TURF PAINT APPLICATOR
1020



T. STRIP
0125



GREEN ROPE
0117



T.STRIP WITH WORDING
0125A



WHITE ROPE
0116



TURF PAINT

1021G 1021Y 1021 1021B 1021R



“Tacit linemarker paint is the best quality for getting the job done”

Mark Campbell, Course Manager
Fortrose Rosemarkie Golf Club

ON COURSE TRAFFIC CONTROL

RECONSTRUCTED PLASTIC FENCING POSTS

With stainless steel spike and slot to allow 6mm rope access

FENCING CHAIN

White chain 25m

White chain is conveniently reeled on a 40m bulk roll. Available in white or green, our 8mm chain will stand the test of time.

CHAIN HOOK

TACIT BARRIER HOOPS

An easy and cheap way of converting your barrier hoops to include large bold signage.

Made from knitted polyester and fixed in place with Velcro; barrier hoops can be put in place in seconds and due to the nature of the sign can easily be removed, washed and replaced to keep the temporary sign looking clean and fresh. Also available with your own personalised message.

TACIT BARRIER HOOP COVERS

T. STRIPS 250MM LENGTHS

TURF PAINT

Xylene free Line Marker paint in an assortment of colours specifically designed and manufactured for use on specialist turf areas.

ROPE

Green rope with black and yellow flecks provides an obvious barrier whilst blending into the environment. Coiled for easy handling and convenience, 220m of 6mm line is wound on every reel.

TRAFFIC CONTROL

GROUND SOCKET TOOL
0199T



SOCKETS
0199

WHITE CHAIN
0114



GREEN CHAIN
0112

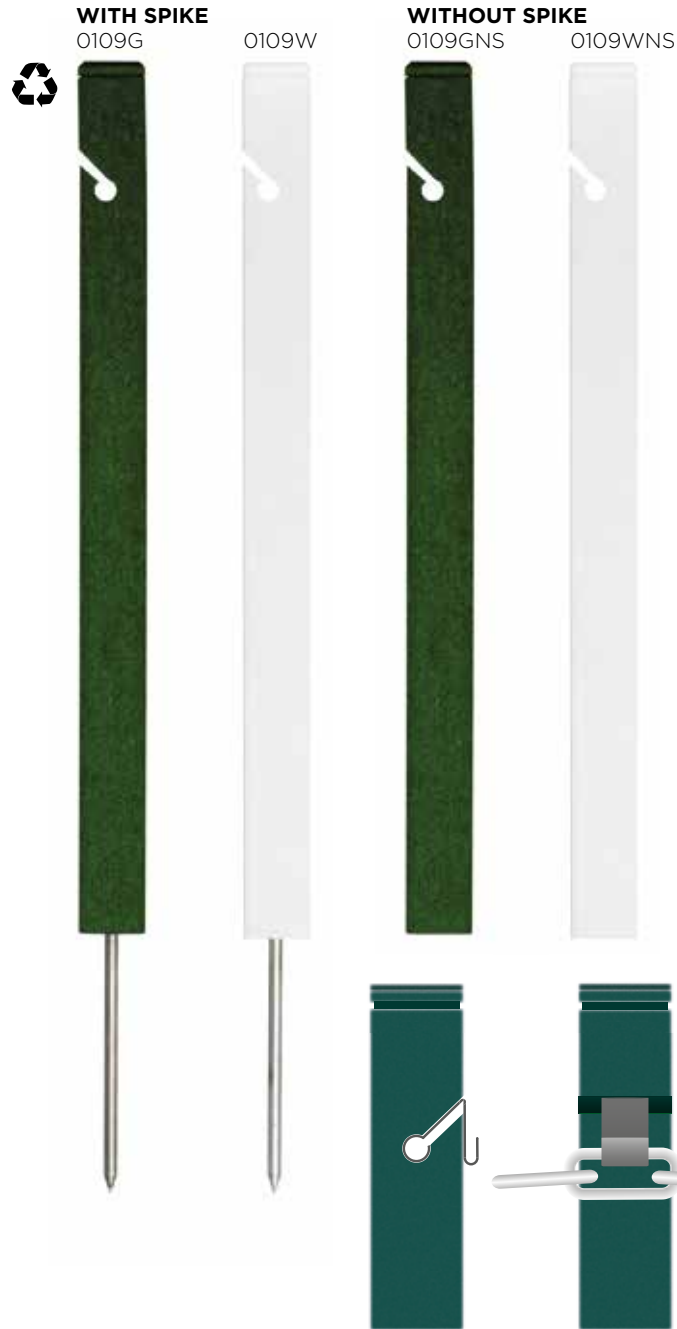

BARRIER HOOP COVER
4950CGKAW

SEE PAGE 53



BARRIER HOOP
0118

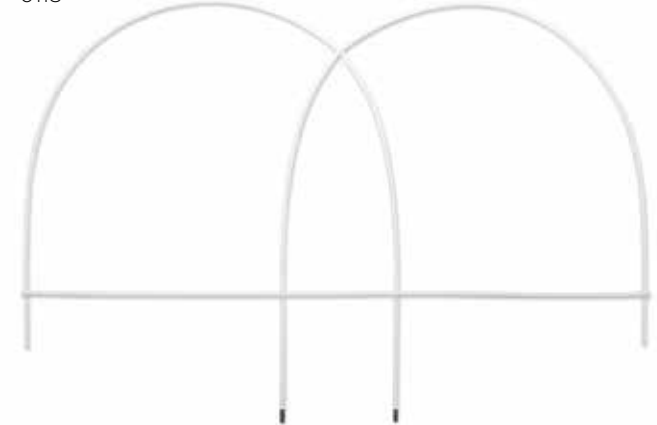

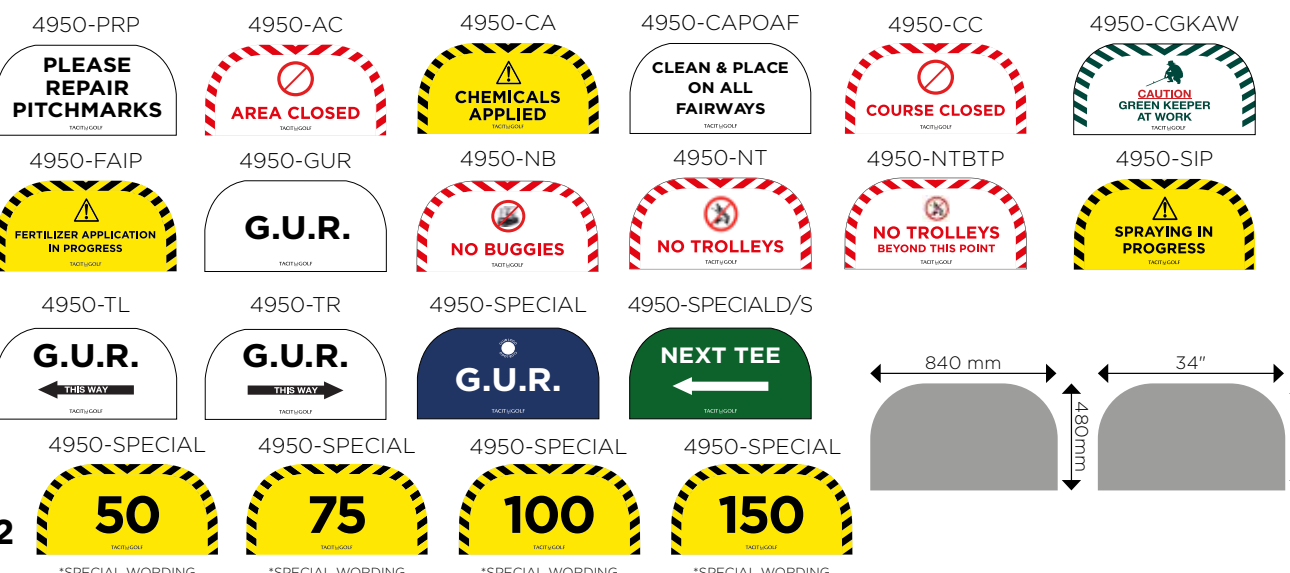
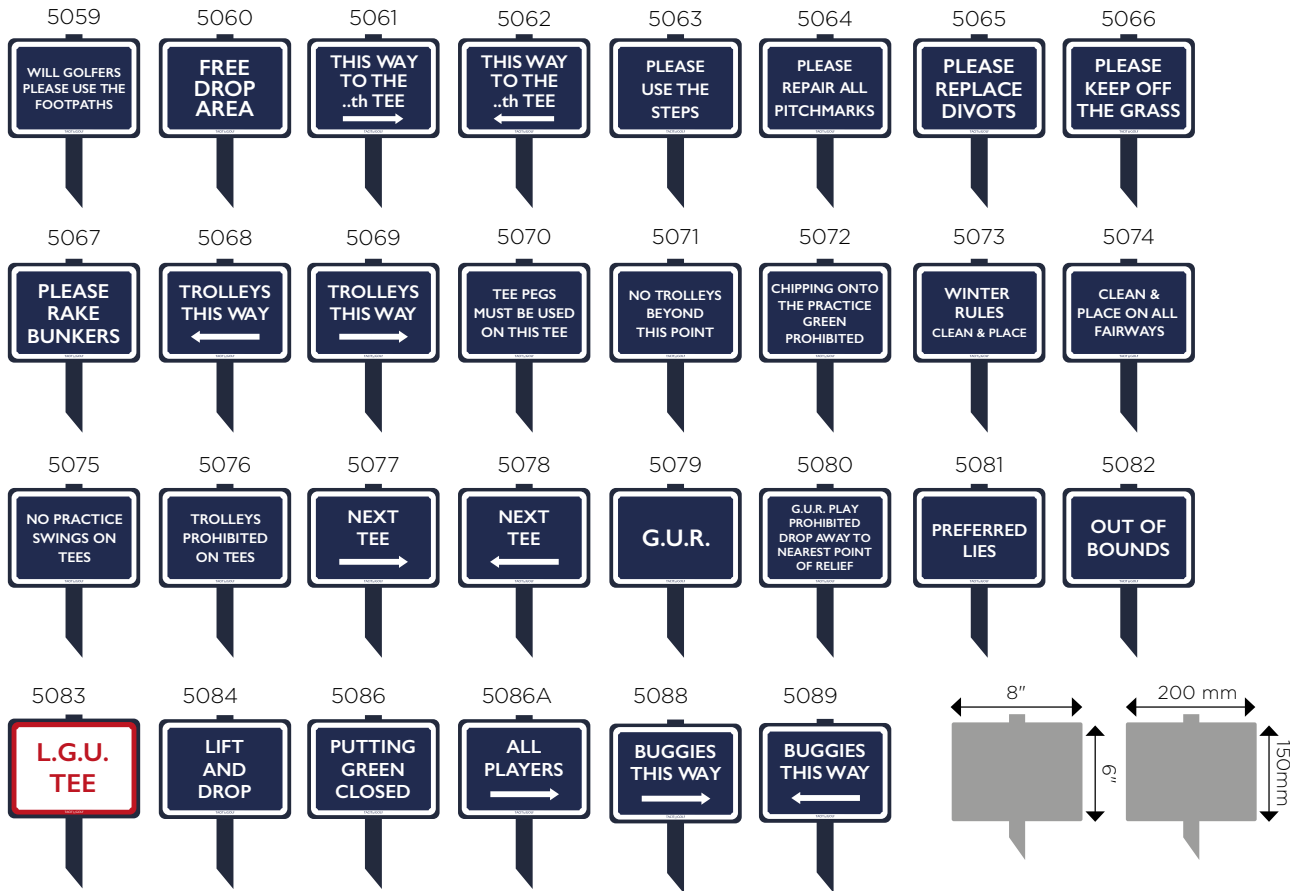

ON COURSE SIGNS

DOUBLE SIDED SIGNS

Two signs for the price of one! Have visitors had problems finding their way around your golf course? Double sided directional and etiquette signs are the answer. Directional double sided signs do the work of two signs for the price of one, pointing golfers the right way no matter what their approach.

INFORMATION AND ETIQUETTE SIGNS

200mm x 150mm
Made from heavy gauge aluminium plate, hidden rivets and green stove painted for durability.

BARRIER HOOP SIGNS

An easy and cheap way of converting your barrier hoops to include large bold signage. Made from knitted polyester and fixed in place with Velcro; barrier hoops can be put in place in seconds and due to the nature of the sign can easily be removed, washed and replaced to keep the temporary sign looking clean and fresh. Also available with your own personalised message.

200mm x 150mm

“ Tacit’s Barrier Hoop & Barrier Hoop Cover are a good combination; discreet but do a job well ”

Charles Edgar, Course Superintendent
Castle Rock Golf Club

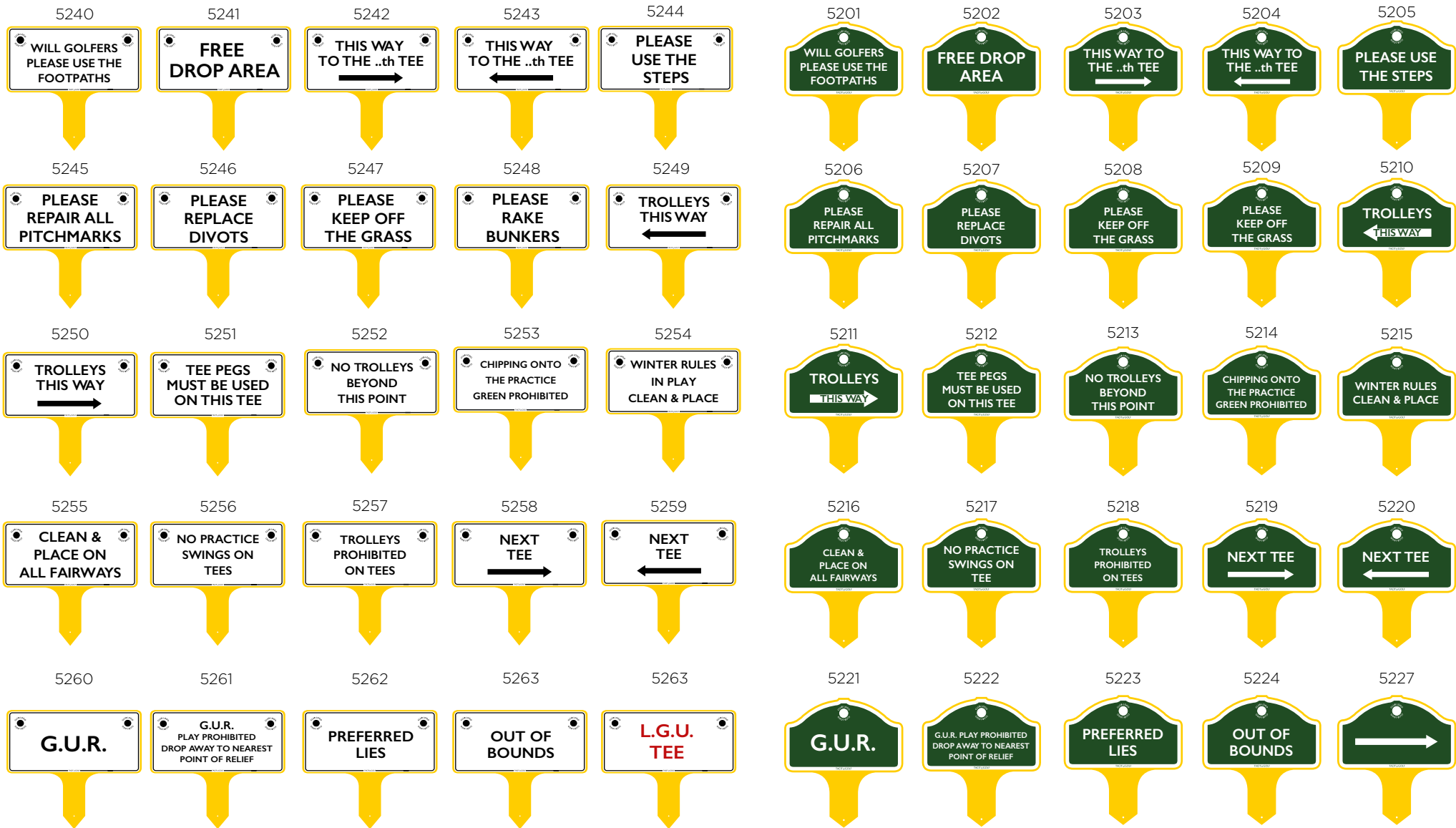

* SPECIAL WORDING MADE TO ORDER

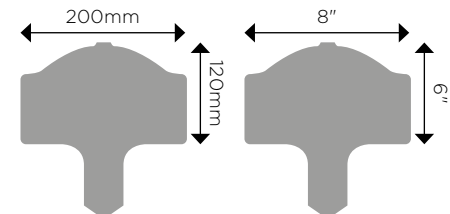
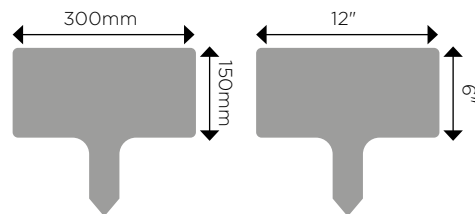

STANDARD SIZES

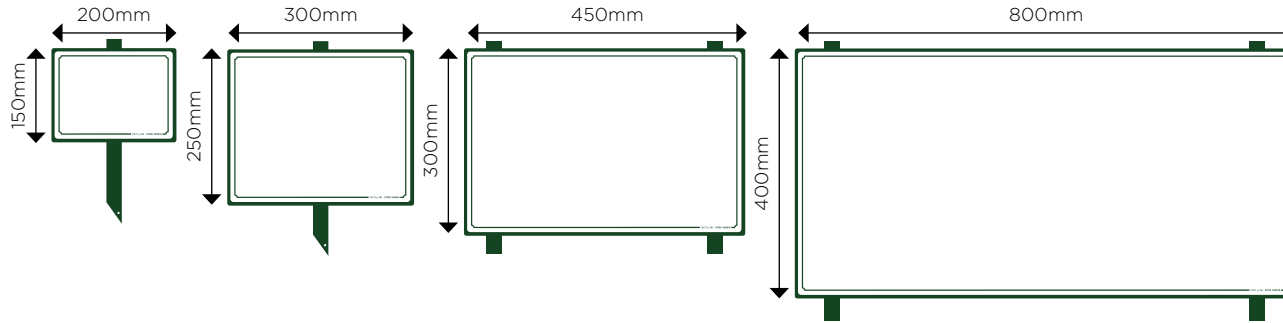

SPIKE 5114, PLATE 5115



SPIKE 5118, PLATE 5119



SPIKE 5130, PLATE 5131



SPIKE 5102, PLATE 5103



SPIKE 5120, PLATE 5121



SPIKE 5096S, PLATE 5096P



SPIKE 5097S, PLATE 5097P



SPIKE 5104, PLATE 5105



SPIKE 5122, PLATE 5123



SPIKE 5098S, PLATE 5098P



SPIKE 5099S, PLATE 5099P



SPIKE 5106, PLATE 5107



(SPIKE) 5124, (PLATE) 5125



(SPIKE) 5116, (PLATE) 5117



(SPIKE) 5108, (PLATE) 5109



(SPIKE) 5126, PLATE 5127



SPIKE 5100, PLATE 5101



SPIKE 5110, PLATE 5111



SPIKE 5128, PLATE 5129



SPIKE 51112, PLATE 5113



OUR SPECIAL SIGNS ARE ONLY LIMITED BY YOUR IMAGINATION, ASK FOR DETAILS

ON COURSE SIGNS

GOLF COURSE SIGNS-300MM X 250MM

Made from heavy gauge aluminium plate complete with hidden rivets and stove printed for durability.

INFORMATION BOARDS

Design by consultation. See Page 10

TACIT SPECIAL SIGNS

Our range of Special Signs are available with or without a spike or ground socket fitting. Supply us with the message you want and we will do the rest.

A 150 x 200mm, B 250 x 300 mm, C 300 x 450 mm, D 400 x 800 mm.

CAR PARKING SIGNS - 300mm x 200mm

Made from heavy gauge aluminium plate complete with or without a spike.

SPECIALS & CORPORATE SIGNS

Using the latest technology, Tacit's sign team are waiting to create signs specifically for your course. All signs can be custom made to any size and with any colour combination to suit your requirements. The inclusion of your club logo is our speciality. Call us now or speak to your area representative for more details or a sample.

“The accuracy and efficiency of Tacit's sign department means I have quality signs on the course at a moments notice”

Chris Gosdon, Head Greenkeeper
St Georges Hill Golf Club

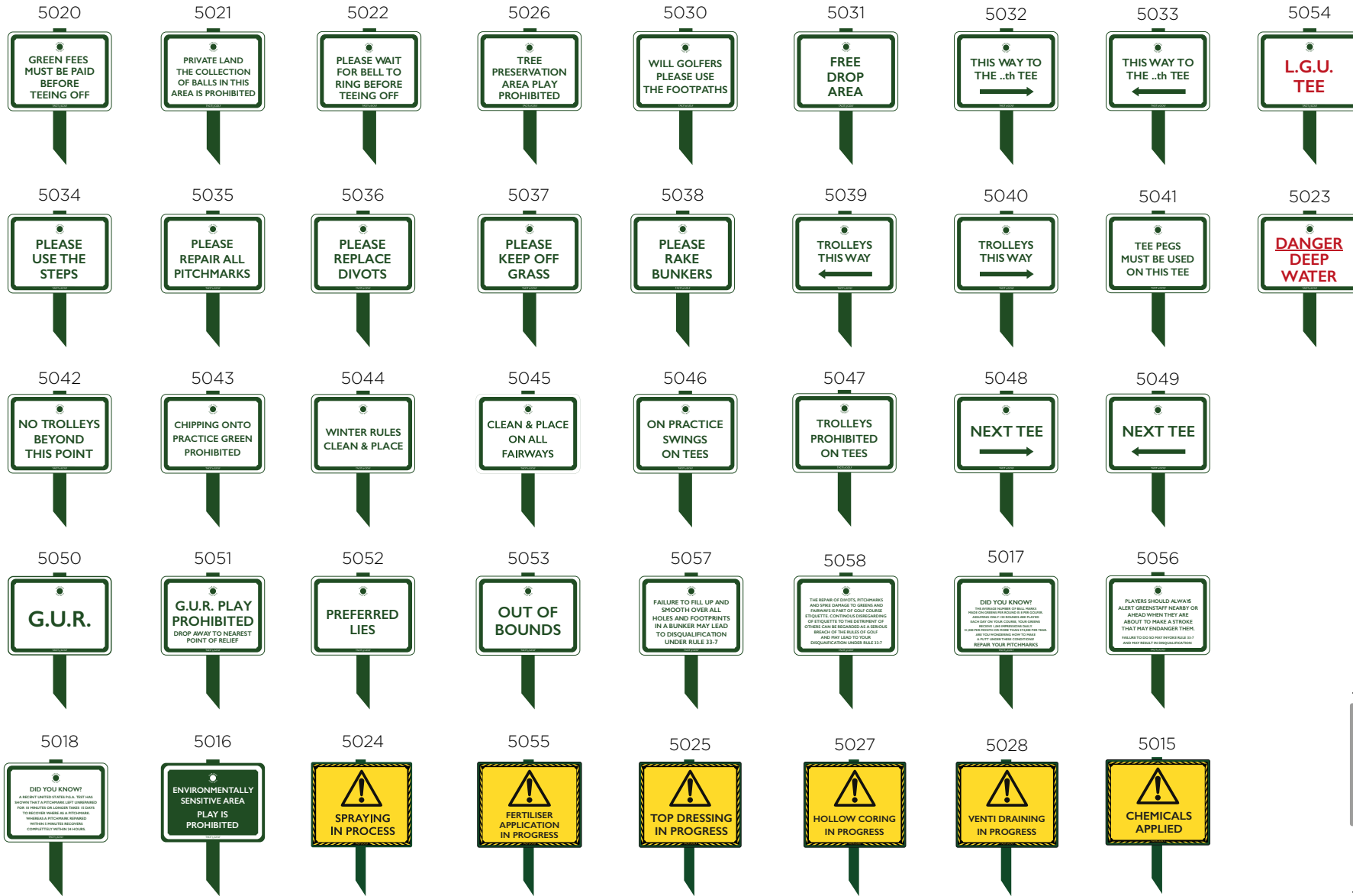

INFORMATION BOARDS DESIGNED BY CONSULTATION

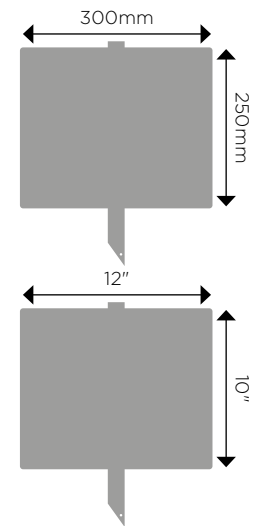



GREEN AREA LOGO FLAGS

LOGO FLAGS

- Full colour matching
- Matching existing flags
- Embroidering available
- Quadruple stitched leading edge
- Variety of different fittings & materials
- Highest quality screen printing

CLUB HOUSE EMBLEM FLAGS

We are renowned throughout the UK and Europe for the craftsmanship and skill we put into the production of our Club House Emblem Flags. All Club House Flags are appliquéd both sides to give a perfect finish.

EMBROIDERED FLAGS

Wholly manufactured in Rugby, England by skilled operators, Tacit's embroidered flags need to be seen to be believed.

Using only the best embroidery thread available, it's combined with artwork that is specific to every shape or form, it's no wonder that everyone is insisting their embroidered flags are made by Tacit.

GREEN AREA LOGO FLAGS

TYPES OF STITCHING

FOUR STITCHED LEADING EDGE



DOUBLE STICED LEADING EDGE



WINTER TEMPEST FLAG

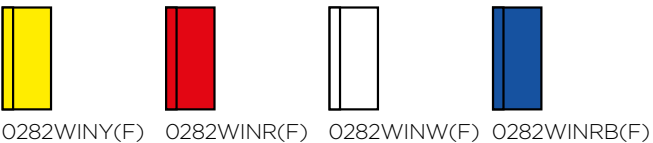

FITTINGS AND MATERIALS

TIE



TUBE

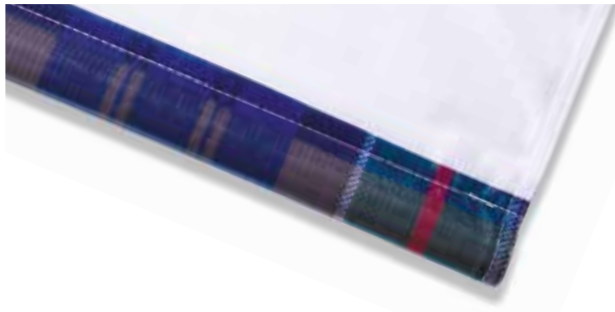

VELCRO



EMBROIDERED FLAGS

- Stitched logo on nylon flag
- Made in England
- Large eye-catching designs
- Double sided
- Readable on both sides
- Anti-fungal material
- Short turnaround times
- Superior quality

SCREEN PRINT

- Ink printed onto nylon
- Hand made in England
- Traditional method
- Ink is ingrained into the material
- Vibrant colours
- Sharp images
- Reads correctly from both sides
- Excellent for television events

DIRECT PRINT

- Ink printed by machine and heat cured onto knitted polyester
- Quick supply times
- Cheap
- Single or double sided
- Deal event flags
- Lightweight

LOGO FLAGS

- Full colour matching
- Matching existing flags
- Embroidering available
- Quadruple stitched leading edge
- Variety of different fittings & material
- Highest quality screen printing

WINTER TEMPEST FLAGS

- Especially for high wind courses
- Tempest material construction
- Lightweight material will pick up in all winds
- 13" / 330mm x 4" / 10mm
- Less stress on pins, cups and golfers wrists
- Material guaranteed for 2 years

“Simply the best logo flags on the market”

Peter Todd, Course Manager
The London Club

LOGO FLAGS

EMBROIDERED FLAGS



SCREEN PRINTED FLAGS



DIRECT PRINT FLAGS

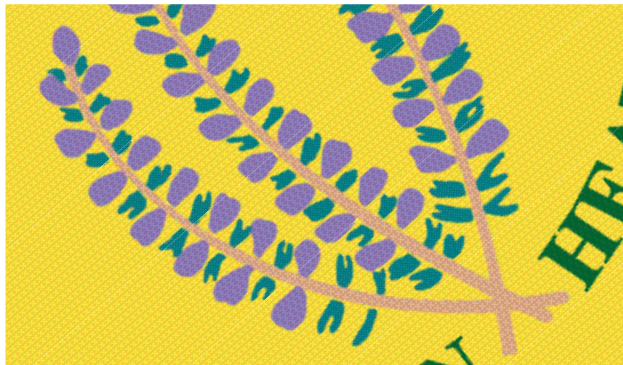

HARLEQUIN FLAGS

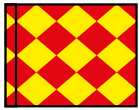

Tube 0730
Velcro 0290
Tie-on 0295
Tempest
 0287RY(F)
Temp Velcro
 0288RY(V)
Temp Tie-on
 0289RY(T)

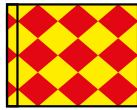

Tube 0731
Velcro 0291
Tie-on 0296
Tempest
 0287YR(F)
Temp Velcro
 0288YR(V)
Temp Tie-on
 0289YR(T)

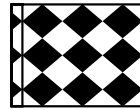

Tube 0732
Velcro 0292
Tie-on 0297
Tempest
 0287WB(F)
Temp Velcro
 0288WB(V)
Temp Tie-on
 0289WB(T)

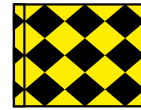

Tube 0733
Velcro 0293
Tie-on 0298
Tempest
 0287YB(F)
Temp Velcro
 0288YB(V)
Temp Tie-on
 0289YB(T)

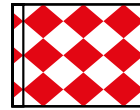

Tube 0734
Velcro 0294
Tie-on 0299
Tempest
 0287WR(F)
Temp Velcro
 0288WR(V)-
 Bracket
Temp Tie-on
 0289WR(T)

PIN PLACEMENT FLAGS



0360
Tournament
 0300Y



0361
Tournament
 0300R

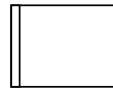

0362
Tournament
 0300W



0363
Tournament
 0300SB



0365
Tournament
 0301Y



0366
Tournament
 0301R



0367
Tournament
 0301W



0368
Tournament
 0301SB

N.B. A nylon pin placement collar with thumb screw is available and designed for ease of use when positioning flag.

13mm Collar 0370
16mm Collar 0371
Tournament Collar 0374



GREEN AREA STANDARD FLAGS

TACIT VELCRO & TIE-ON FLAGS

Tacit have the deserved reputation of producing the best flags in the business, made from high quality Nylon or Polyester and completed with Tacit's Signature 4 stitched leading edge to minimise fraying. Tacit's flags will outlast any other flags on the market. Try them and be prepared to be impressed.

TUBE FLAGS

The Tube Flag is now the standard for USGA Specification Flagsticks made from superior materials and incorporating Tacit's signature 4 stitched leading edge. Tacit's tube flag is the only one that comes with a flange stitched into the flag to give superior visibility and wear. The tube flag is easily held in place with Tacit's unique Turret nut which accepts tightening by hand, screwdriver or spanner.

TEMPEST FLAGS

Having scoured the textile world Tacit have found a material so durable we are willing to guarantee 12 months wear before the material breaks down. Combined with our reputation for the longevity of our stitching this flag has no equals.

No other company will guarantee their flags for 12 months - **WE DO!**

HARLEQUIN FLAGS

"Outstanding" is the only word to describe this latest Tacit innovation. Be the first to try the Tacit Harlequin Flags and let the others just fade away. Made to Tacit's usual exacting standards, double sided and available in a range of colours and fittings.

PIN PLACEMENT FLAGS

Made to Tacit's exacting standards and manufactured in a variety of colours, Tacit's Pin Placement Flags are available plain or with a request to repair pitchmarks.

N.B. A Nylon Pin Placement collar with thumb screw is available and designed for ease of use when positioning flag.

STANDARD FLAGS

TACIT VELCRO & TIE-ON FLAGS

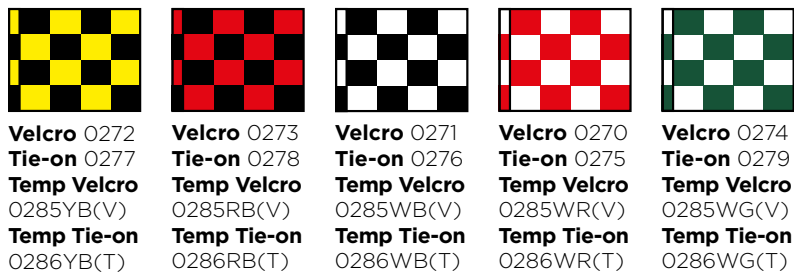
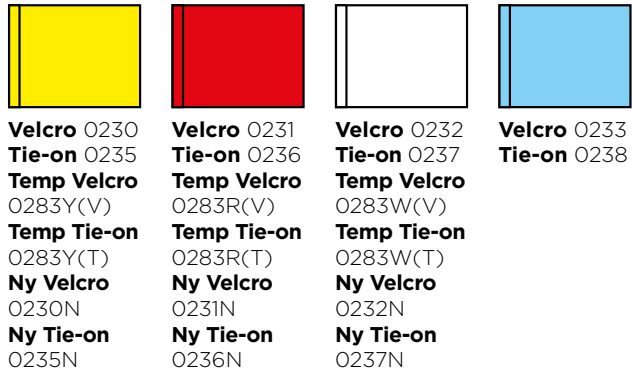
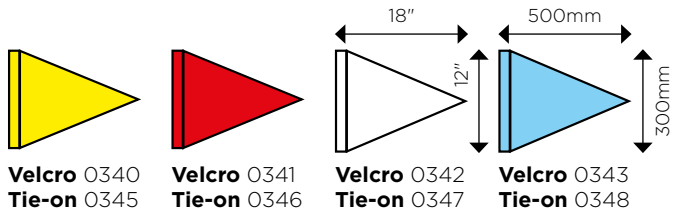

TUBE FLAGS

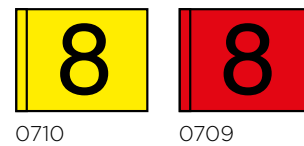
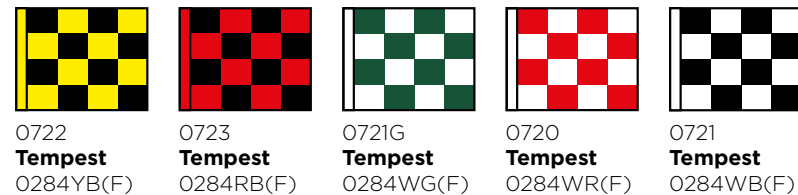
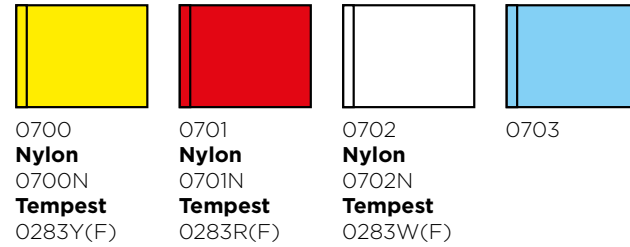
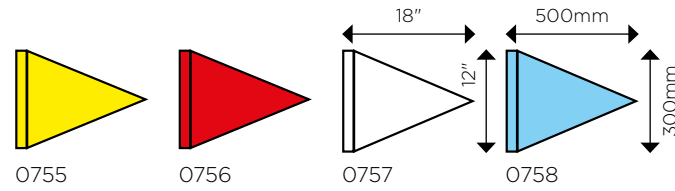

“ Tacit’s range and quality has become both extensive and of a very professional standard. This alone makes it striking to both the course manager and the golfer ”

Gareth Roberts, Course Manager
Hankley Common Golf Club

WINTER FLAG CLIP

The idea for Winter Flag Clips came as a direct result of listening to our customers. Mr J.J. Young – Course Manager at Tralee Golf Club used to put elastic bands on his flags to reduce their size in the severe windy weather in the winter on the west coast of Ireland to protect his golfers' wrists and the course equipment.

We at Tacit took the idea and developed the Winter Flag Clip. By rolling the flag around the tube the flag can be shortened to the desired length and then held semi permanently in place. When the weather abates the clips can be removed in seconds and the flag instantly returned to its original length. Alternatively the flag can be shortened for the duration of the winter with the flag clips resulting in the lifespan of the flag being greatly extended.

0895FS

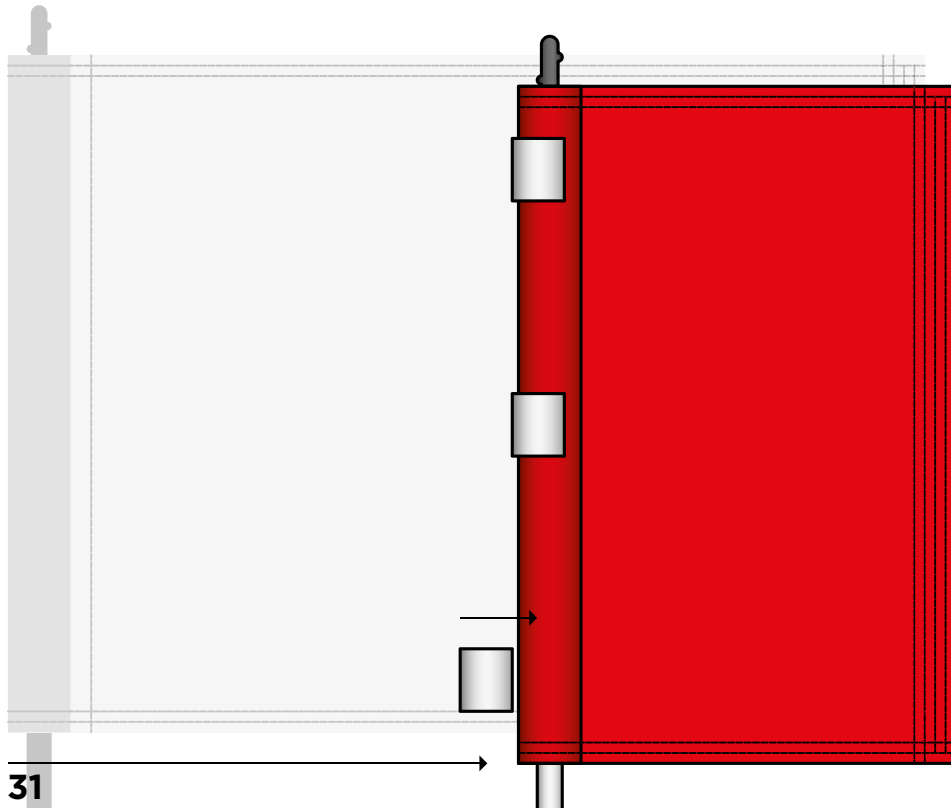

1. Roll flag to a third of its normal size.
2. Attach Winter Flag Clips to the rolled up flag tube.

GREEN AREA FLORIDA KEYS AND WINTER FLAG CLIPS

FLORIDA KEY

An ingenious way of rapidly changing the flag without the hassle of fiddly nuts. It saves time and has no moving parts and hence nothing to break. Also screws on to an existing top ferrule.

The florida key will reposition itself automatically in the wind yet requires just two twists to remove.

WINTER FLAG CLIP

A simple but effective way of shortening the length of the flag, reducing wear and making the flag pin easier to handle in windy conditions.

“Convenient and very easy to use; the Florida Key vastly speeds up the process of switching the flag on the flag stick when the three colour pin placement system is in operation”

John Doyle, Course Superintendent
Wexford Golf Club

FLORIDA KEY

Tacit has finally solved the problem of lost or cross threaded nuts on the flag pins. With its unique key way design, the flag can easily be removed in seconds and replaces just as quickly. Clubs that run the 3 colour pin placement indicator system can quickly and easily change the flags, saving on average 4 minutes per flag change. If the holes are changed daily this equals 72 minutes a day, this is equivalent to the saving of 8 hours a week per week in labour 4 days a month or 48 days a year...

A top stud that has protruding nodes 180° opposed and staggered correspond to a notch in the flag tube so that when the tube is aligned the flag can be moved up one stage. If the flag is then rotated by 180° it can be moved over the second node and removed completely. Replacing the flag takes seconds by sliding the flag over the pin and giving two 180° twists the flag is back in place. If the flag should ride up in high winds it has to swivel another 180° to come off. Due to the set up of the key way the flag will usually return to its original position. The Florida Key is threaded to fit all existing top ferrules so acorn nuts or turret nuts become obsolete.

The Florida Key is solid and has no moving parts so, there's nothing to go wrong. No slots for soil to get jammed in or moving parts to break.

0895FK



FLORIDA KEY

1. Rotate

2. Lift

3. Rotate

4. Lift

5. Remove

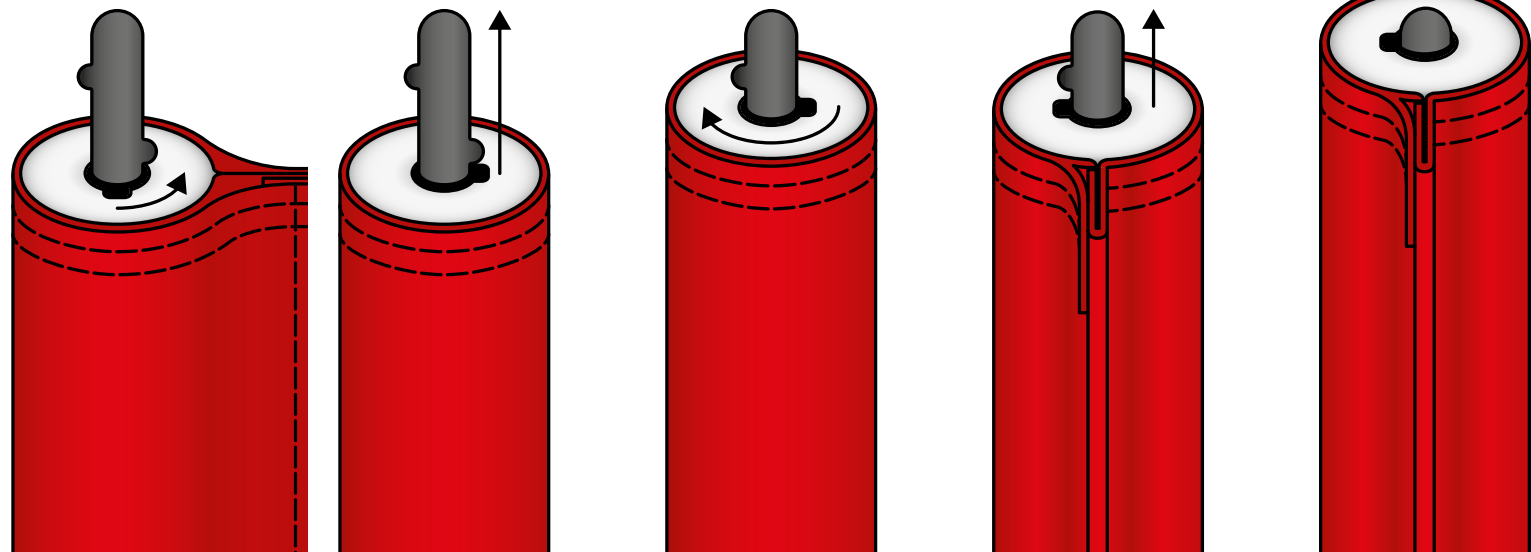



USA Nylon Ferrule
0680

USA Aluminium Ferrule
0681

Turret Nut
0895

Threaded USA Flagpin Top
0896



10ft 0893 0892 0891 0894 0890 0889 0888

9ft

8ft 0879 0880 0881 0886 0876 0877 0878

7ft 0849 0850 0851 0856 0846 0847 0848

6ft 0819 0820 0821 0826 0816 0817 0818

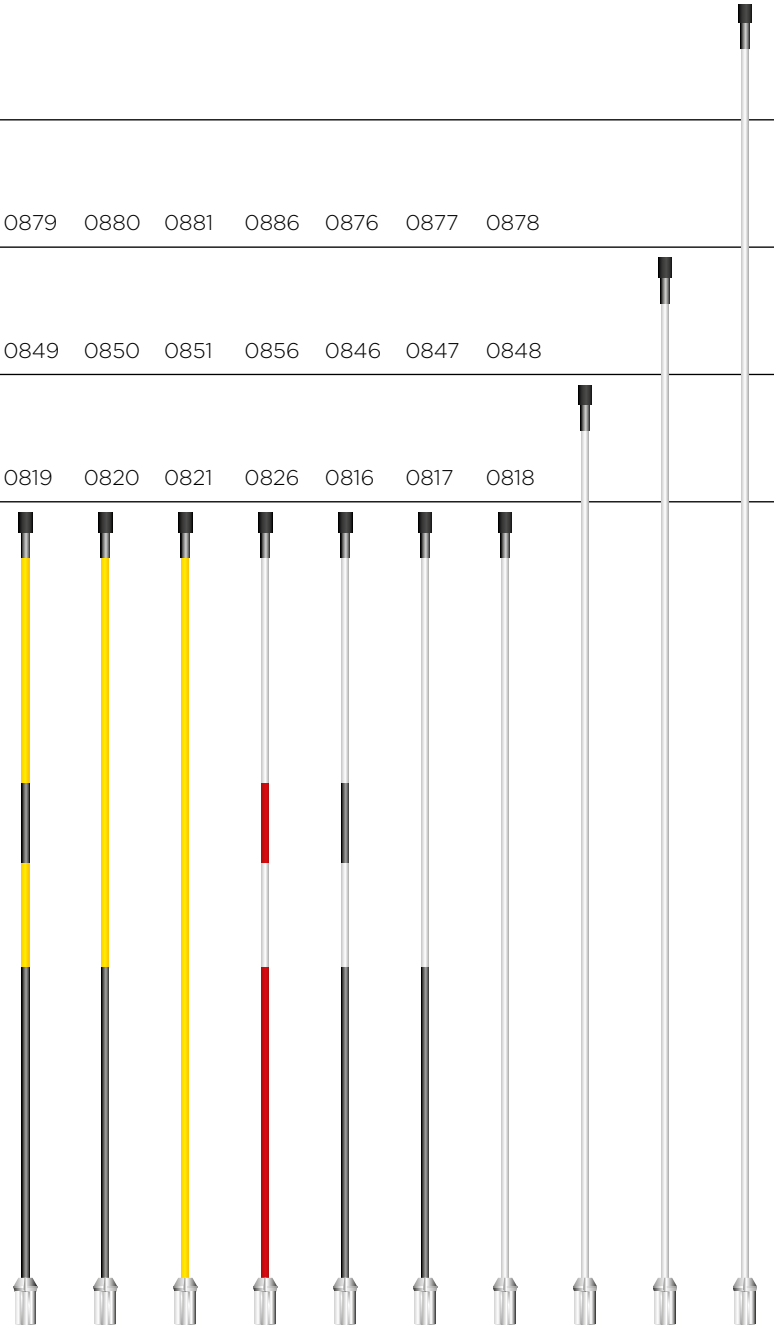

GREEN AREA STANDARD PINS

TACIT'S UK SWIVEL TOUR FLAGSTICK

For velcro or tie-on flags the Tacit flagstick lasts longer because of the simple design of the flagstick and holecup which eliminates the problem of excessive wear and leaning flagsticks. A pattern of splines on the underside of Tacit's anti-wear ferrule stops the stick from rotating and prevents excessive wear while the flag, which is attached to the swivel top of the flagstick, flows freely. The flagstick will accept any type of tie-on flag and is particularly suited to Tacit's neat and convenient clip-on velcro flag.

N.B. Tour Flagsticks come complete with aluminium ferrules as standard

WINTER FERRULE

No more poles blowing out, with this 6" long winter ferrule, designed to fit the Tacit 1/2" or 5/8" diameter flagstick. Combined with Tacit's 'lockon system' this ferrule is the perfect addition for winter conditions or links courses.

For 10ft flagsticks we recommend a Tacit "Extreme" Flagstick fitted with a winter ferrule. **see above**

TACIT'S USA SPECIFICATION FLAGSTICK

For tube flags, Tacit can now offer their latest range of high visibility American style flagsticks with tube flags. The high visibility flagstick is also longer lasting due to the splines on the underside of Tacit's Lockon antiwear ferrule. When used in conjunction with Tacit holecups, the specially designed ferrule locks into place and prevents the flagstick from rotating preventing excessive wear. Comes complete with USA Ferrule and Turret Nut.

N.B. Florida Flagsticks come complete with aluminium ferrules as standard

“The Tour flagsticks Tacit produce are hard wearing and their double sided embroidered flags give a real professional finish”

Steve Robinson, Course Manager
Moortown Golf Club

STANDARD PINS

10ft

0552 0551 0550 0556 0555 0554 0553

9ft

8ft

0532 0531 0530 0542 0535 0534 0533

7ft

0502 0501 0500 0512 0505 0504 0503

6ft

0476 0475 0474 0486 0479 0478 0477

34

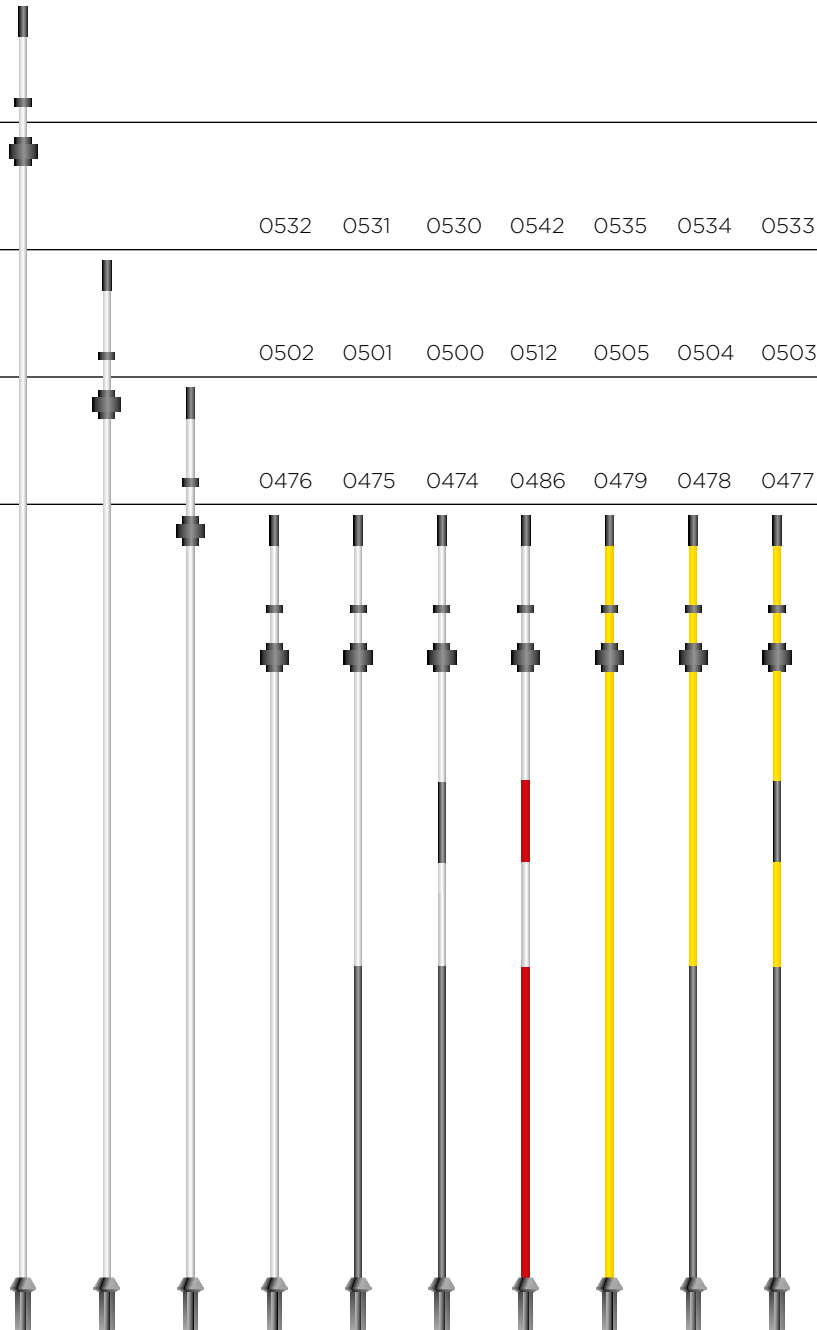

1/2" Winter
Ferrule
0692



UK Nylon
Ferrule
0679



UK
Aluminium
Ferrule
0682



1/2" Top
0677



1/2" Top
Collar
0678



1/2" Swivel
0676



10ft

0643 0640

9ft

MAC DUNES EXTREME FLAGSTICKS

TACIT'S TRADITIONAL RED TOP FLAGSTICK

TACIT'S EXTREME FLAGSTICKS

8ft

0558Y 0558W

0468

0623 0620

7ft

0557Y 0557W

0467

0593 0590

6ft

0466

0563 0560

GREEN AREA TACIT TOURNAMENT (JAVELIN) FLAGSTICKS

TACIT TOURNAMENT (JAVELIN) FLAGSTICKS

Improve the visibility of your flagsticks with Tacit's ultra visible Tournament (Javelin) Flagstick. Standing straight and tall at 7ft, 7'6", and 8ft Tacit Tournament (Javelin) Flagstick is tapered from 19mm in the centre to 13mm at either end. Made from solid colour impregnated composite material and then covered with our highly visible sleeving this is truly the champion of flagsticks. All Tacit flagsticks come complete with Tacit's unique anti-stick, anti-swivel ferrule which results in reduced sticking, reduced ferrule and holecup wear and consequently upright flagsticks lasting longer than all the rest.

* All Tacit's Flagsticks meet GCSA and R & A specifications

The Machrihanish Dunes flagsticks have been developed in conjunction with The Machrihanish Dunes Golf Club in order to create a stiffer flagstick (more wind resistant) that is highly visible in the unique conditions that make up the British coastline.

TACIT'S TRADITIONAL RED TOP FLAGSTICK

Supplied in high visibility black & white stripe Tacit's Red Top Flagstick comes in your choice of sizes from 6ft to 8ft. The perfect budget range flagstick for discerning greenkeepers who like a good price without compromising quality. Sold in packs of 10.

TACIT'S EXTREME FLAGSTICK

Exclusive to Tacit, a more rigid 5/8" diameter flagstick especially designed for very windy courses. Has the same swivel action as our famous tour flagstick. Available in all colours complete with UK or USA anti-wear ferrule.

**TACIT TOURNAMENT
(JAVELIN) FLAGSTICKS**

10ft

**TACIT TOURNAMENT
(JAVELIN) FLAGSTICKS**

9ft

**MACHRIHANISH DUNES TOURNAMENT
(JAVELIN) FLAGSTICKS**

8ft

0668W 0668R 0669 0669Y 0669YBB 0668 0669YBS 0658W 0658Y

0660 0667 0661 0662 0663 0664 0665

7ft

0671W 0674 0671WBB 0671Y 0674YBB 0671 0671YBS 0656W 0656Y

6ft

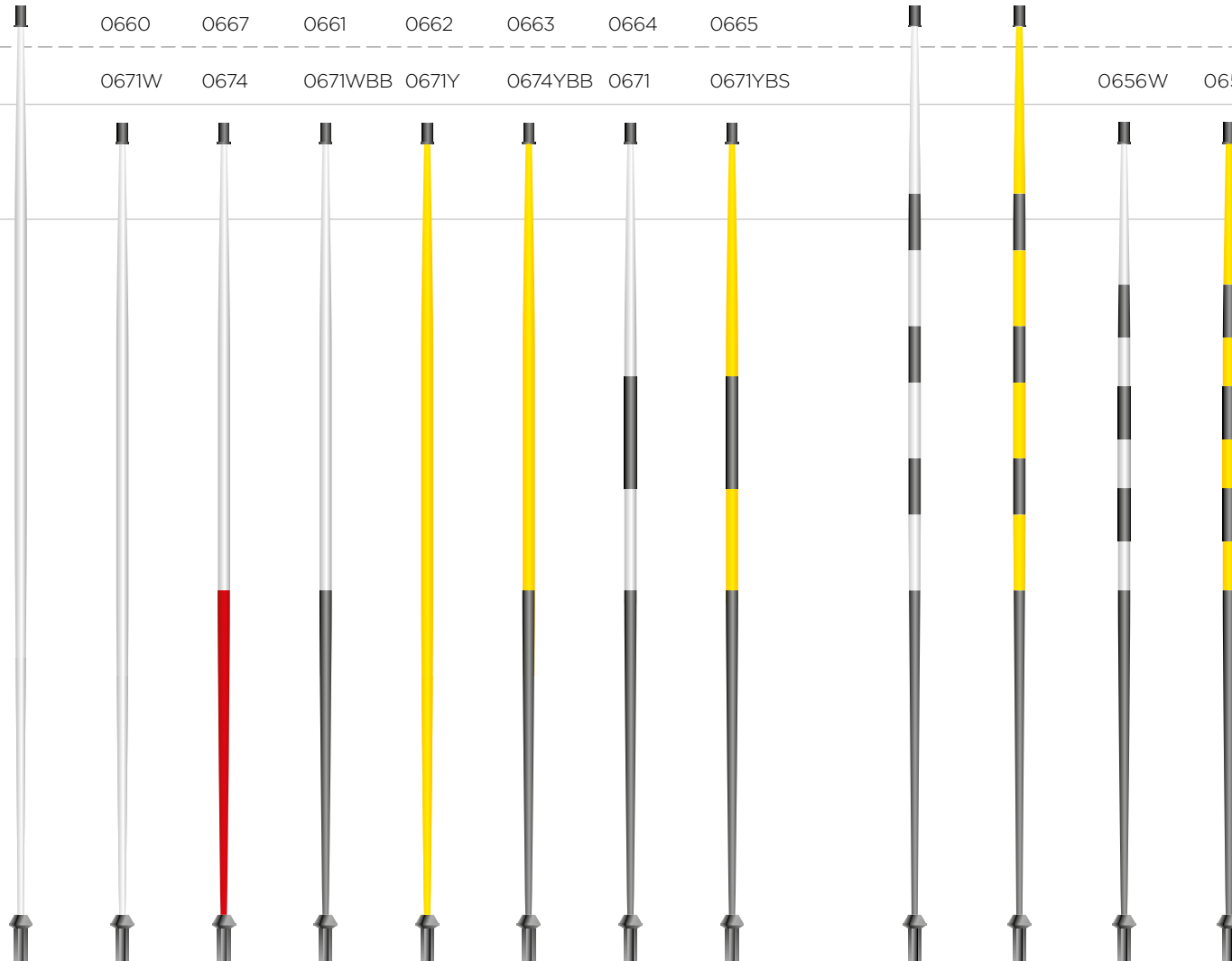

“The best performing wind flagstick I have ever used”

Simon Freeman, Course Manager
Machrihanish Dunes



GREEN AREA **HICKORY**

Tacit's Hickory Flagstick has been made to recreate the look and feel of courses at the inception of Golf.

Hickory wood is known for its hard wearing and flexible properties, coupled with stainless steel results in a truly individual, stylistic and long lasting addition to any course.

Available in 8' as standard and also as a matching putting green marker or chipping pin.



FULL SIZE
0520



CHIPPING
0521

PUTTING
0523



CARRY WASH BASKET
0898SS



GREEN AREA HOLE CUPS

TACIT STOP HOLECUP

Tacit's revolutionary new holecup ends the ever sinking holecup. The sub cap on the underside increases the ambient surface area by 300%, stopping the holecup sinking below the R & A recommended 1" depth. The sub cap also stops rootzone from entering from the bottom of the holecup and up through the central ferrule socket allowing the ferrule on the base of your flagstick to locate itself perfectly every time.

- STOP Flagsticks blowing out
- STOP Holecups sinking
- STOP Ferrule wearing out
- STOP Flagsticks leaning over

HOLECUP COVERS

CARRY WASH BASKET

Designed to hold 10 cups at a time, the stainless steel construction of the basket allows dirty cups to be easily transported back to base, jet washed out and returned to the green without excessive handling.

“At St Andrews Links, we have found the Tacit holecups to be long lasting, especially the liners which are excellent. More importantly they stand up well to windy conditions and help the hole keep its shape”

Gordon Moir, Director of Greenkeeping
St Andrews Links Trust

6" HOLECUP COVER
0932



4¼" HOLECUP COVER
0931



HOLECUPS

TACIT STOP HOLECUP SYSTEM

Twenty years ago Tacit developed an Anti Swivel Ferrule / Holecup combination that has now been adopted by the majority of courses throughout Great Britain and Ireland. Indeed it is so good that some of the competitors have attempted to take the idea and produce anti swivel systems of their own.

Tacit have now taken another leap forward with the introduction of the Sub Cap to the central Ferrule bore, thus reducing holecup sinkage and reducing substantially the amount the ferrule will wear.

How has Tacit achieved this? Imagine the ferrule on the bottom of flagstick to be a pebble in a stream. Imagine the holecup to be a rock pocket that has collected the pebble, as the pebble turns within the hole, both the pebble wears smaller, whilst the hole wears bigger. How to stop the wear? Simple, stop the movement.

This is where the splines on the underside of Tacit's ferrule come into their own. Although unobtrusive, the splines instantly locate in the corresponding holes in the holecup and stop the flagstick from rotating within the holecup. Instead of the flagpins needing

to be replaced annually, there is now a two year renew cycle. Adding Tacit's sub cap to this scenario could lead to a three or four year renew cycle, as the wear on the ferrule and holecup is slowed even more.

Without this excessive wear brought about by ferrule rotation, the flagstick stays upright longer, with the chances of the flagstick blowing out of the holecup in strong winds being substantially reduced.

Why add a Sub Cap? The only way flagsticks will blow out of the hole or wear excessively, is if the ferrule is not locating correctly in the hole. On a busy course, the flagstick is relocated every 10 to 15 minutes throughout the day; the holecup is constantly hammered deeper and deeper into the hole. Originally set to the R & A recommended 1" depth, the holecup can end up 2" below the surface after a few days, especially in U.S.G.A. specification sand greens. The Sub Cap increases the ambient surface area by over 300%, allowing the holecup to effectively float in the green. The ingress of soil up the middle of the holecup is completely stopped but the cup can still be bedded solidly into the root zone.

Without this bedding in of the holecup the cup will rapidly rock loose. The flagstick and ferrule can then sit in the holecup in perfect harmony and work together at their optimum in their own little grit free world. As the ferrule / holecup combination is grit free, the ferrule and holecup do not jam and therefore the holecup is not pulled out of the ground when the flag is being tended.

But what about the cup itself? Tacit's holecup is unique in that it works opposite to all the other cups on the market, while they have been designed to move all the debris and topdressing down the centre bore causing all sorts of problems with wear and "ferrule jam" the Tacit holecup is designed to shed all that unrequired rubbish through the outer windows keeping the central bore clear. Constructed from aluminium (LM24) and machined to exact tolerances in the UK by skilled time served craftsmen, the leading edges are given a taper both top and bottom allowing for ease of setting and extraction of the cup whilst maintaining an exact 4¼" diameter to the body of the cup.

But the "pièce de résistance" must be the wrap contained in the cup. For years superintendents have had to struggle with damaged and chipped paint coming off the cups. With the introduction of a plastic wrap all these problems have been instantly eradicated. The cup stays bright and white month after month. When it needs changing it is replaced cheaply and in seconds because it is constructed of a very fine surfaced PVC, dirt and dust are not easily engrained unlike other similar sleeved designs. These other sleeved designs also have an inherent weakness in that a screwdriver has to be pushed down the front edge of the cup in order to release the sleeve, damaging both cup and sleeve in the process while Tacit's wrap is easily removed through the use of a hidden keyhole. However, the most profitable side of the cup is its ease of ability to be logoed or branded. This can be done cheaply and easily while flat either locally or ordered in specially, the advertising space can then be sold over and over.

TACIT STOP HOLECUP

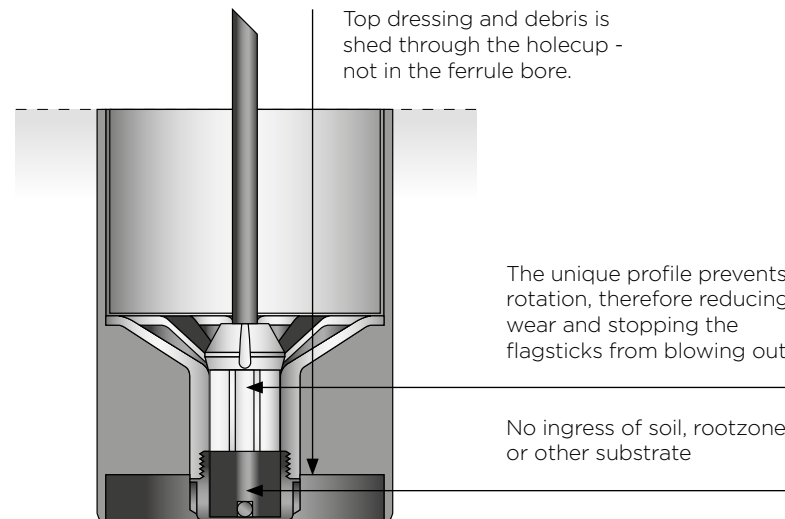
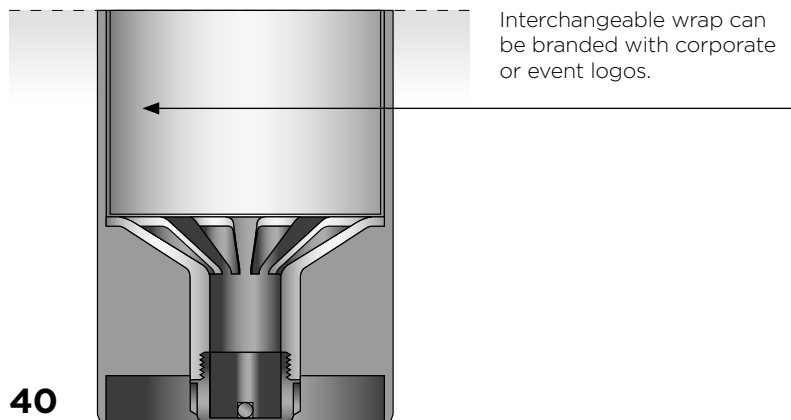

USA HOLECUPS

ABS
0918



ALUMINIUM
0899PL



GREEN CUP
0918A



PUTTING
0985



WINTER
0903



HOLECUP INSERTS

Plain 0899S
(Pack of 20)



GREEN AREA HOLE CUPS

UK HOLECUPS

UK White Holecup
Aluminium STOP Holecup UK
UK Winter Holecup
UK Putting Cup
UK Green Holecup

HOLECUP INSERT / WRAP

Aluminium Holecup 20 Sleeve Pack
Sub Cap for UK Aluminium Cup

USA HOLECUPS

USA White STOP Holecup
White Sub Cap (Pack of 10)
Aluminium STOP Holecup USA
USA Winter Holecup
USA Putting Cup
USA Green STOP Holecup
Green Sub Cap (Pack of 10)

HOLECUP INSERT / WRAP

Aluminium Holecup 20 Sleeve Pack
Sub Cap for USA Aluminium Cup

HOLECUPS

UK HOLECUPS

ABS
0900



ALUMINIUM
0900A



GREEN CUP
0900G



PUTTING
0986



WINTER
0902



HOLECUP INSERTS

Plain 0899S
(Pack of 20)



“ Tacit Aluminum Holecups are top quality with a unique locking system. Using the Tacit sub cap means less wear on the ferrules and therefore no blow outs ”

Darrin Easingwood, Head Greenkeeper
Archerfield Links



SHOLE HAMMER HOLECUTTER
1013BCOM



SHOLE SHOE
1013SHOE H



OUTSIDE SHARPENED
1013NON



INSIDE SHARPENED
1013COM



GREEN AREA HOLECUTTING

TACIT TURF DOCTOR - WINTER HOLECUTTER

Designed and manufactured in the same way as Tacit's legendary Close Tolerance holecutter. Tacit's 150mm Turf Doctor removes turf quickly and effectively, leaving a perfect hole for either turf replacement or the setting of a winter holecup.

TURF DOCTOR REPLACEMENT BLADES

Tacit's heavy duty blades are made from high tensile steel and pressed into an exact shape before being case hardened and zinc plated.

TACIT CT HOLECUTTER

A legend in it's own time, the Tacit CT Holecutter is relied upon by the P.G.A to cut exact holes for major events throughout Europe. Through the use of laser technology Tacit have manufactured the most accurate and durable holecutter on the market today. Incorporating adjustable handles for stability combined with a simple to use depth gauge and razor sharp case hardened steel blades Tacit's holecutter is the recognised market leader throughout Europe. Beware of imitations, insist on the original. * Cuts holes to USGA and R & A specifications.

CLOSE TOLERANCE BLADES (CT BLADES)

State of the art manufacturing systems have allowed Tacit's Holecutter to be made with blades so close they nearly touch, resulting in a perfect hole every time with no ripping or tearing where the blades meet.

SHOLE HAMMER HOLECUTTER

The Tacit Shole Holecutter cuts an exact 108mm hole every time with an integral hammer action. With an upright operation, it is easy on the back, with a unique effortless core extraction system. The whole unit weighs less than 10kg! The bullseye spirit level makes sure every hole is cut level. It also comes with easy interchangeable compression / non-compression blades with an optional adjustable depth gauge.

HOLECUTTING

TACIT CT HOLECUTTER
0912

TACIT TURF REPAIRER - WINTER HOLECUTTER
0914

“The original and still the best the CT Holecutter keeps going while many of its rivals crumple at the challenge”

Gareth Roberts, Course Manager
Hankley Common Golf Club



CT BLADES
0913



WINTER HOLECUTTER BLADES
0915



CUTTING BOARD
1013HG



RINGS
1013HGR



NANO GAUGE
0925NANO



ALUMINIUM SETTER 28MM
0925



NYLON SETTER 25MM
0925N



GREEN AREA HOLECUTTING

TACIT HOLE CUTTING TOOLS

Hole Trimmer / Setter Aluminium
Rubber Mallet
Stainless Steel Cup Lifter / Rammer
Hole Trimming Scissors
Water Bottle
Gripper Twin Handle Hole Cup Lifter
Sprung Hole Cup Lifter

GREENKEEPERS BUCKET

The Greenkeepers' bucket gives Greenkeepers the ideal place to store all the tools required for hole cutting. Easily carried out onto the green and with no sharp edges to damage or mark the green; the required tools are always handy and together. The central area can also be used for storing seed and top dressing for any emergency repairs.

HOLECUTTING BOARD WITH DEPTH GAUGE

So simple its brilliant.
Interlocking rings are attached to the holecutting board to give the depth of cut required. No guess work, every hole is cut exactly to the set depth, no more sunken or scalped old holes no matter which member of staff is cutting the holes.

SETTER FINISHER

NANO GAUGE

A lightweight, pocket sized, hole gauge for use prior to and during tournaments for setting the cup and also assuring the hole is always the correct shape and size.

Machined to an exact 108mm diameter and 25mm in depth, from a solid aluminium block the hand gauge can instantly be used to correct the size and shape of the hole.

As used by referees at major tour events.

HOLECUTTING

GREEN KEEPERS BUCKET
0937



HEAVY RUBBER MALLET
0928



WATER BOTTLE
0939



GREENKEEPER SCISSORS
0929



ALUMINIUM SETTER 28MM
0925



“ Tacit’s Nano Gauge is a precision tool which has been an invaluable help at re-setting damaged holes to the exact size during our event. It’s lightweight and fits easily into my pocket ”

James Crampton,
Director Of Championships
England Golf

GRIPPER LIFTER
0959



LIFTER RAMMER
0926



SPRUNG LIFTER
0954



GREEN AREA PUTTING GREEN

CHIPPING FLAG
0983Y



PUTTING CUPS

UK
0986

USA
0985



CHIPPING PIN
4501

GREEN SPEED METER
1022

HOLE STABILISING RINGS
0907



PUTTING GREEN ARROW
0990

0990L



1m

FLAG TYPE

Flags plain numbered or customised. Other colours available.
 Red Plain Set of 9
 Red Numbered Set 1-9
 Yellow Plain Set of 9
 Yellow Numbered Set 1-9
 White Plain Set of 9
 White Numbered Set 1-9
 Blue Plain Set of 9
 Blue Numbered Set 1-9

BACK SAVER TYPE

With your logo on one side and a choice of white, black or blue top with red numbers on a white background on the reverse.

White Numbered Set 1-9
 White Numbered Set 10-18
 Blue Numbered Set 1-9
 Blue Numbered Set 10-18
 Black Numbered Set 1-9
 Black Numbered Set 10-18
 Gold Numbered Set 1-9
 Gold Numbered Set 10-18
 Chrome Numbered Set 1-9
 Chrome Numbered Set 10-18

ECONOMY PUTTING MARKER

White Top with Number Stem

HOLE STABILISING RINGS

CHIPPING PIN

CHIPPING FLAG

Plain
 Yellow
 Red
 White

PUTTING CUPS

USA Putting Cup
 UK Putting Cup

TACIT GREEN SPEED METER

Knowing your green speed is not just for the satisfaction of your captain, it will also allow you to consider the following:- effects of aeration, spiking and top dressing, mowers used, types & heights of cut, watering practices, double cutting, rollers, brushes, combs and a host of others. Try one and see.

P.S. Don't tell the club captain you bought it!

PUTTING GREEN ARROWS

Our Concorde Putting Green Arrows are numbered and cast from aluminium with a hardwearing powder coating.



PUTTING MARKER

0948ALM

0984ALM

0964ALM

0952AL

0962ALM

ECONOMY PUTTING MARKER

0953N

RED BALL
0992

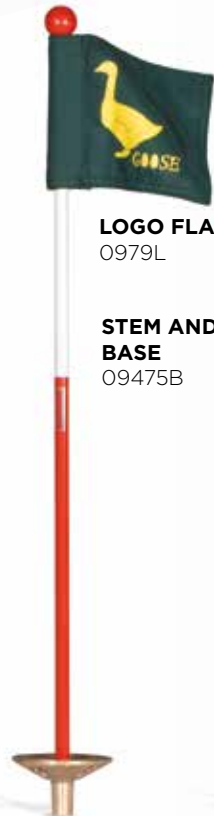

LOGO FLAG
0979L

STEM AND BASE
09475B

BLACK BALL
0993



LOGO FLAG
0979L

STEM AND BASE
09475B



STEM AND BASE
0958

“The Tacit 16P Rake is useful for many different tasks, but is especially good for raking damp and wet bunkers giving a great finish when compared to other rakes”

Jamie Brooks, Head Greenkeeper
The Belfry

MAINTENANCE RAKE
0157



WOODEN HAY RAKE
6007



16P LONG
6001SL



16P SHORT
6001SS



MAINTENANCE RAKES

BUNKER STONE RAKE

A finer mesh allows the stainless steel to remove objects from the bunker not less than 5mm in diameter, collecting them for easy removal into a bin. The unique teeth on the underside of the rake break the surface and allow debris to be easily collected from the bunker.

16P LONG TOOTH - A CLASSIC

16P SHORT TOOTH

Modified specifically for bunker maintenance; the short teeth will not penetrate bunker linings nor will they go deeper than the PGA tournament recommended depth of 1".

MAINTENANCE RAKE

Makes short work of even the largest bunkers. Long teeth break up the sand while the short teeth collect any surface debris. Ideal for moving large amounts of sand towards the front of the bunker and on the face. Also ideal for clearing and collecting organic debris.

WOODEN HAY RAKE

16P LONG TOOTH CURVED

Designed specifically for the rounded edges of bunkers, this slant on the original classic gives a much better finish to all bunkers.

16P SHORT TOOTH CURVED

Created for the maintenance of pot bunkers this rake will only penetrate the PGA Tournament recommended 1" depth whilst being able to get into all those fiddly little round edges.

MAINTENANCE RAKES

BUNKER STONE RAKE
0167



16P LONG CURVED
6001L



16P SHORT CURVED
6001S



LAWN LEVELLER
1015

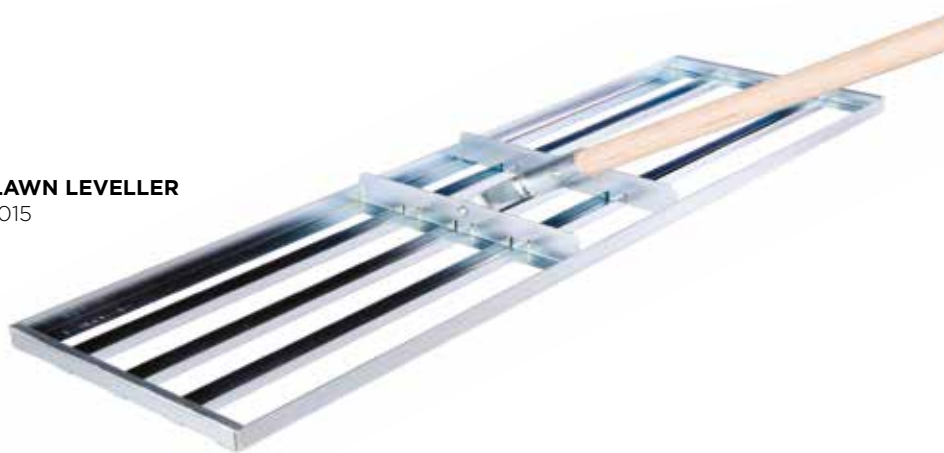

DRAG MAT
1038

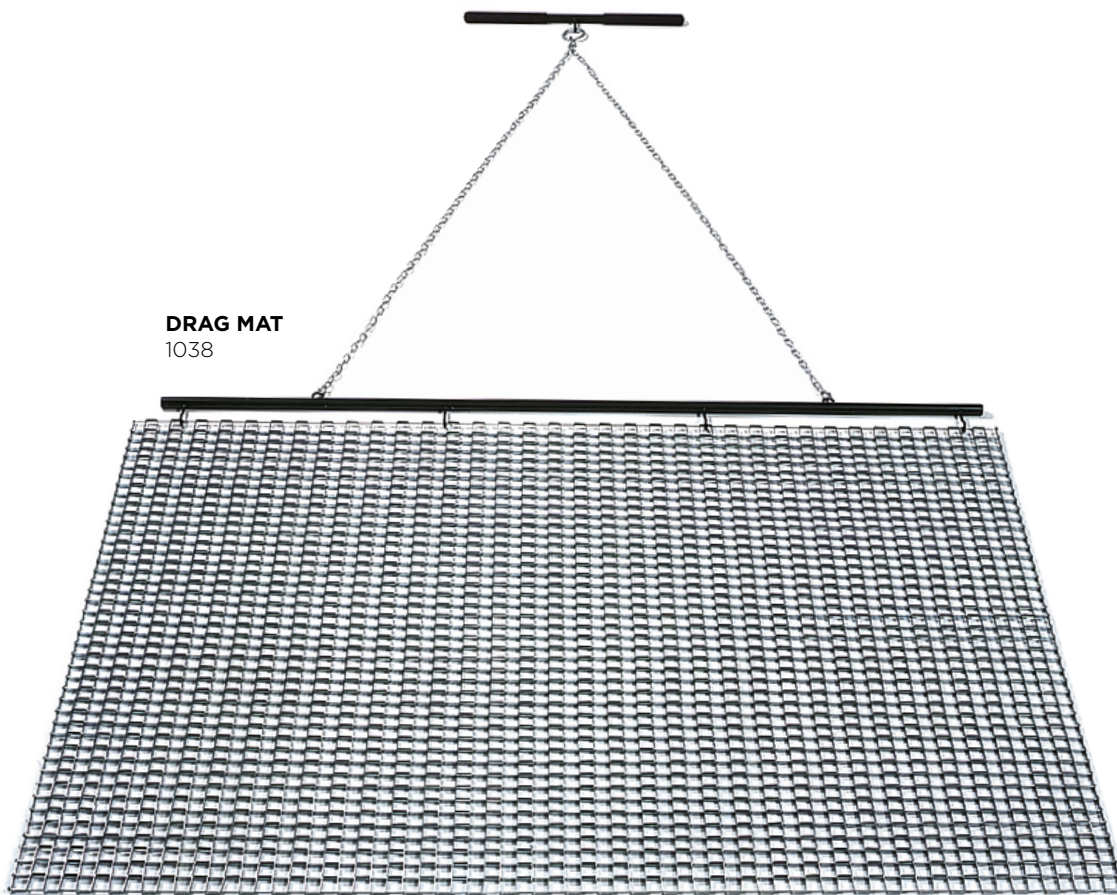

MAINTENANCE FINE TURF TOOLS

OPEN CORER (AGRONOMIST KNIFE)

S.T.R.I. recommended. Graded at 50mm points along the shaft to identify the depth of the sample. Moisture and compaction can be assessed without the hindrance of an end loop. Light and easy to carry. Stainless steel construction will last a lifetime.

EDGING KNIFE

Extra heavy duty professional one-piece edging knife.

SPRINKLER HEAD TRIMMER - 3.5 INCH

Lightweight but robust. All trimmers come with case hardened blades. The 3.5 inch unit comes complete with its own handle.

SOIL PROFILER

S.T.R.I. recommended. The professional's choice for sampling root zone characteristics. Razor sharp blades cut a sample 200mm x 85mm x 18mm. The sample is easily removed for inspection and just as easily replaced in the same hole. Due to Tacit's unique hinged flap there are no separate parts to lose. Comes oven painted in burgundy.

LAWN LEVELLER (LUTE)

Tacit's Lawn Leveller (lute) is manufactured specifically for use on fine turf areas. The Lawn Leveller is ideal for spreading and grading a variety of sands and top dressings providing a super flat fine surface.

DRAG MAT

2m Drag Mat comes complete with draw bar and chains.

FINE TURF TOOLS

OPEN CORER
1018



EDGING KNIFE
6029

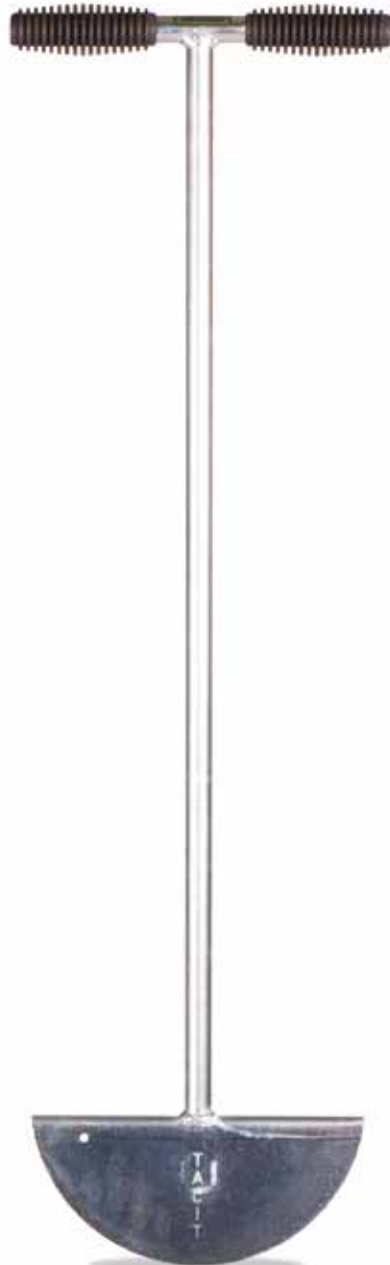

3½" SPRINKLER HEAD TRIMMER
1000



SOIL PROFILER
1017



REJOINER

After extensive research Tacit has yet again come up with a totally new and innovative idea to solve an age old problem of repairing damaged turf on the green.

The rejoinder allows the Greenkeeper to remove damaged, diseased or dead turf from the green and be replaced with an exact fit from the nursery green or from an area on the edge of the green that is less likely to be "in play".

The uniqueness of the Rejoinder comes in the shape of the super sharp cutting head. It is well known that grass does not grow in straight lines, consequently, the shape of the cutting head has no straight lines. This allows the new sod to knit much faster to the surrounding turf.

Combining this with a shape that not only locks itself in place when used individually but with contoured edges to lock into place no matter how much area needs to be covered; as a result the fine roots put out by the new sod are allowed to penetrate the surrounding soil and not broken by the movement of the replaced sod when it experiences pedestrian traffic.

This locking of the sod in place also means the lateral surface creep of the grass is encouraged. The sod then becomes an integral part of the green in a much shorter time.

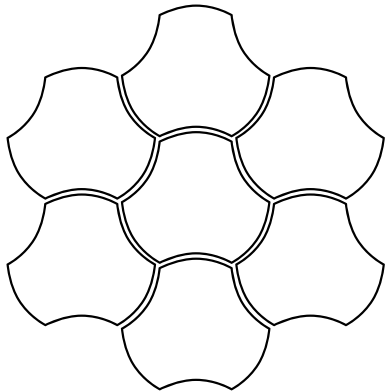

Example of the Rejoinder pattern.

0919J



MAINTENANCE FINE TURF TOOLS

HOLE GROOMER ("THE CLIPPY")

Use the NEW Tacit hole groomer and you can guarantee easy and consistent results every time. Manufactured to Tacit's exacting standards the hole groomer removes the time consuming process of hole top trimming. For a fantastic crisp finish that reinstates the hole to an exact 108mm in between cutting new holes. Using the Tacit hole groomer couldn't be simpler, place the device into the hole, pull up the handle, turn twice and remove. A perfect cut every time, in a fraction of the time. Perfect for reinstating the holes on the putting green. Bracket for mower attachment available.

REJUVENATOR

Restores ball marks, animal tracks and indentations in the green to the original putting surface level. No tamping needed, tailored for effective ergonomic use. Virtually no maintenance, stainless steel tines give your green the perfect finish.

REJOINER

Unique interlocking turf repair tool that allows damaged turf on the green to be repaired quickly and easily. The distinctive shape encourages the turf to knit in much quicker than other straight sided designs.

SEED SLOTTER

Specialist tool for overseeding worn areas etc on all fine turf areas. The rotary slotter unit will not tear up the surface and correct depth is obtained by the rotary stops at each end of the slotter reel. By providing a flat bottomed slot at the correct optimum depth of 1/2" (13mm approx), the seed 'turns' during the rapid germination period of less than 7 days. Moisture in the soil is more easily absorbed by the seed, encouraging stronger root growth, within a protected environment. Ideal for fescue germination.

SPIKER

A specialist agronomy tool the rotary spiker aids water / air penetration and stimulates root growth. Spikes made to a specific depth due to the rotary stops at each end of the spike reel. Can also be used to provide seed with a deeper germination depth when overseeding.

FINE TURF TOOLS



SPIKER
1040

SLOTTER
1039

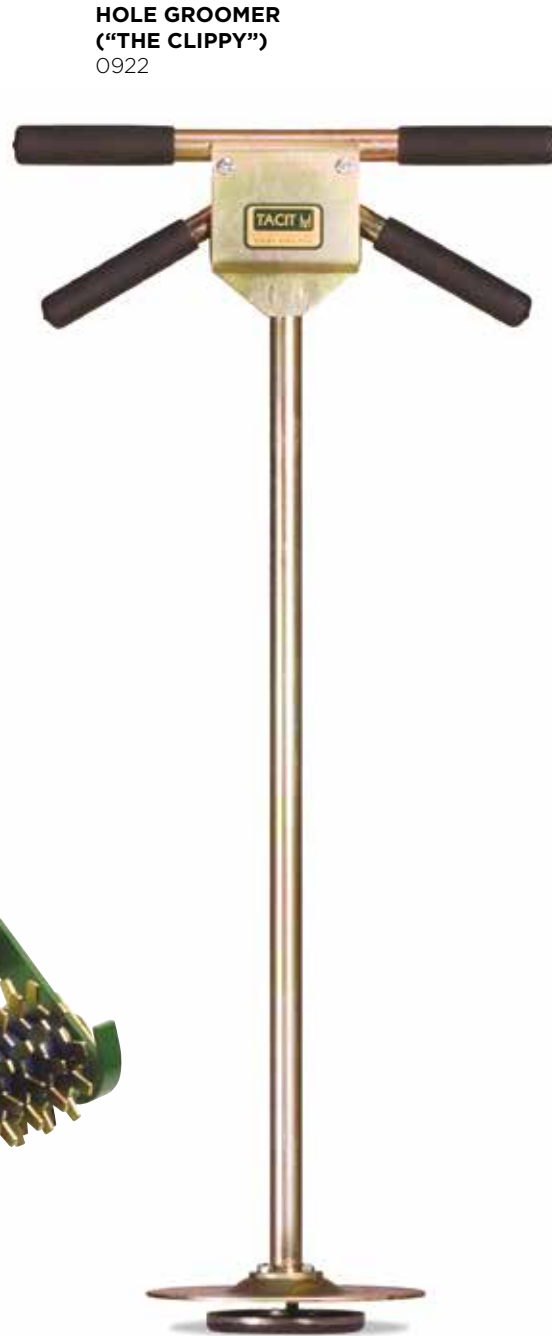

HOLE GROOMER
("THE CLIPPY")
0922



REJUVENATOR
6040

“The Low Pressure Switch is the preferred switch; robust, self cleaning and easy to use”

John Chantrell, Head Greenkeeper
Lilleshall Hall Golf Club

DEW BRUSH (HARD)
1035

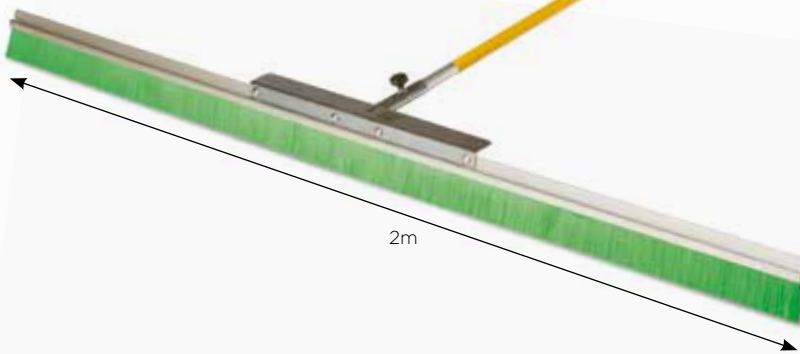

DEW BRUSH (SOFT)
1033

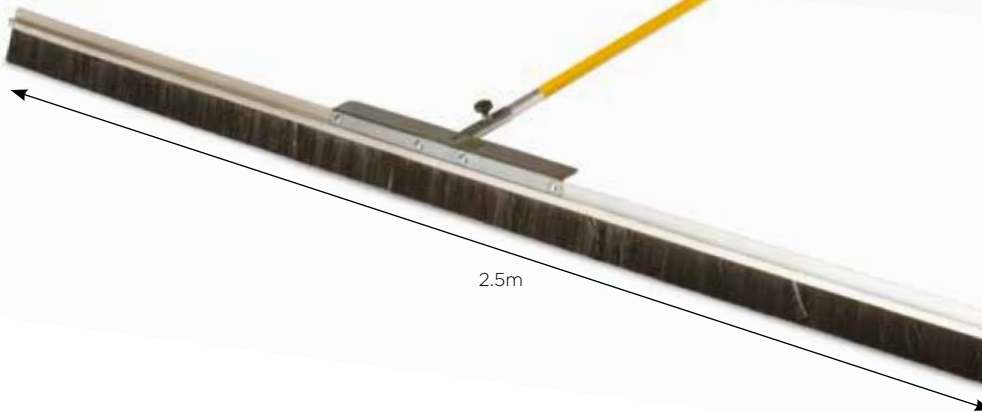

MAINTENANCE **WATER/DEW REMOVAL**

TACIT LOW PRESSURE SWITCH

Tacit's Low Pressure Switch is now the established standard in the industry. With its stiffer 8.5mm switch tip and its unique pull and lock fixing device, Tacit's Switch clears greens of dew quicker and more completely than any other switch on the market. An anodised aluminium shaft stays rust free whilst Tacit's soft grip provide a warm hold on the chilliest of days.

ROLLER SQUEEGEE

Lightweight and robust, Tacit's Squeegee is the ideal tool for removing excess water from your greens without damaging the sward. A soft core allows for compression of the roller whilst the extra tough skin gives it protection and durability.

THE 2 IN 1 DEW BRUSH

Tacit produce 2 Dew Brushes for the discerning greenkeeper. The original Black 2.5m Dew Brush with soft bristles that glides easily over the green clearing dew with a squeegee action, whilst the newly developed Green 2m Dew Brush with stiff bristles flicks the dew into larger droplets forcing them to be absorbed by the soil. Both are light and easy to carry and both use Tacit's Switch as their handle.

STRAIGHT SWITCH HANDLE

WATER / DEW REMOVAL

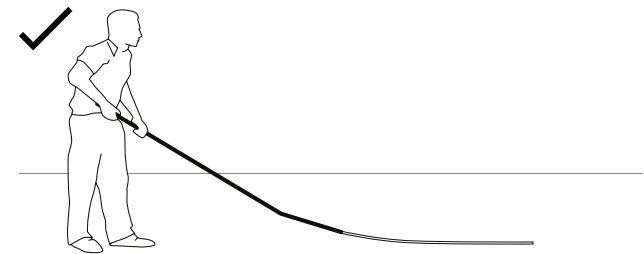
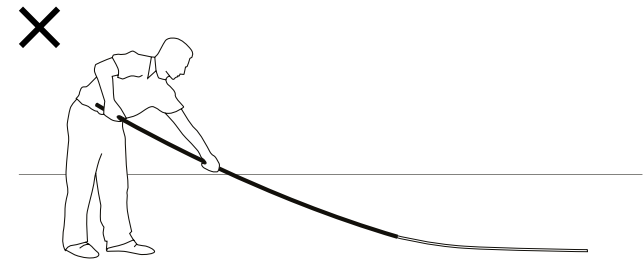
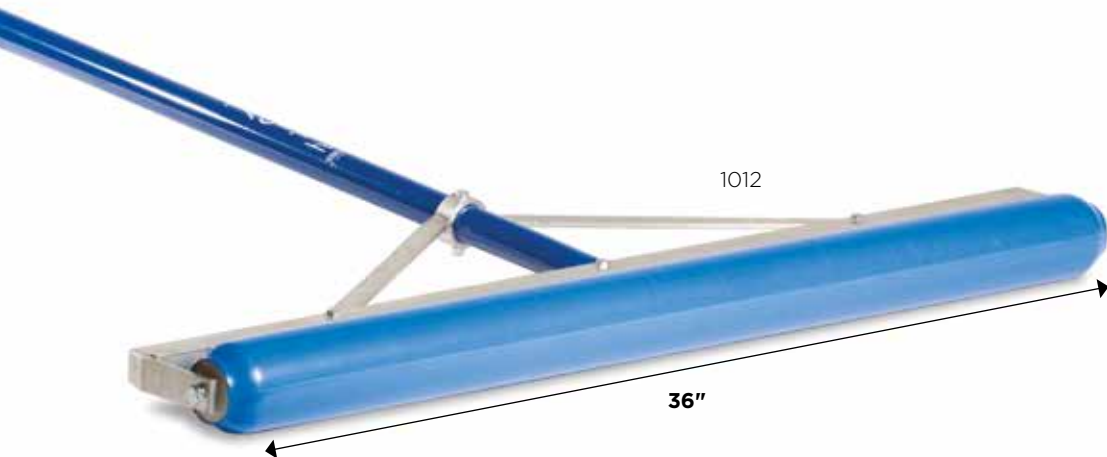
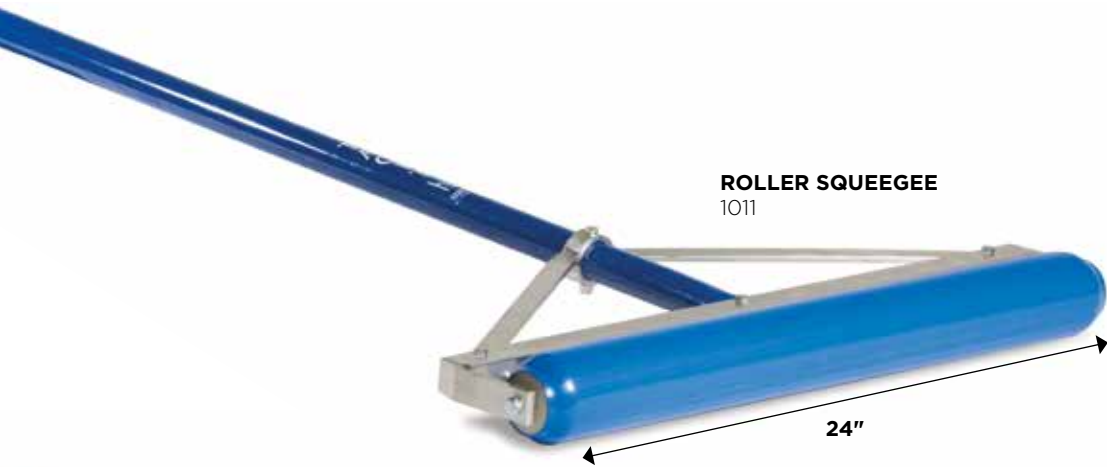

Take the hard work out of switching with Tacit's unique Low Pressure Curved Switch.

ORDER PLANNER

OCTOBER

TACIT ARE PROUD TO SUPPLY:



NOVEMBER



DECEMBER



59 Moat Farm Drive
Hillmorton
Rugby
Warwickshire
CV21 4HQ
England

www.tacitgolf.com

EMAIL: sales@tacitgolf.com

TEL: +44 (0)1788 568818

“I am impressed with the excellent fully stocked van service and due to the golf course being situated in a remote part of Scotland this is a great benefit to us, also there being no carriage cost for this facility is absolutely brilliant”

Bobby Mathieson, Head Greenkeeper
Machrihanish Golf Club

ORDER PLANNER

JANUARY

APRIL

JULY

FEBRUARY

MAY

AUGUST

MARCH

JUNE

SEPTEMBER

TERMS AND CONDITIONS

PRICES

Prices quoted in the price guide are correct at the time of going to press. Goods will be invoiced at prices ruling at the time of despatch.

SETTLEMENT

Strictly nett within 28 days of invoice. Interest will be charged on outstanding accounts at 2% above the current bank rates.

SMALL ORDER SURCHARGE

Orders under the value of £35.00 nett value excluding VAT will be subject to a surcharge of £5.00 together with carriage unless otherwise stated.

CANCELLATIONS

Goods returned after 30 days will only be accepted at Tacit's discretion and are subject to a 45% handling charge.

VALUE ADDED TAX

All prices are exclusive of VAT.

GOODS

On receipt these should be examined by consignee. When this cannot be done they must be 'unexamined'. If a clear signature is obtained for "Goods received in a good condition" no claim can be considered.

DAMAGED GOODS

Claims for damaged goods must be notified to the Company's head office by telephone or fax within three days of delivery. Written confirmation to be received by post within seven days of delivery. Claims notified after this period will NOT be entertained.

NON DELIVERY

Non delivery must be notified within five days of receipt of the invoice and confirmed in writing otherwise no liability will be considered.

LIMITED WARRANTY

Tacit warrants its products to be free from defects in materials and workmanship. Tacit's sole obligation under this warranty shall be to repair, replace or refund, to its buyer, the price of the defective product or component. All such repairs, refunds and replacements are subject to rules, terms and conditions that Tacit may promulgate from time to time.

DISCLAIMER OF OTHER WARRANTIES

The foregoing limited warranty is in lieu of all other warranties express or implied, including merchantability or fitness for a particular purpose. In no event shall Tacit be liable for indirect, consequential or special damages of any nature whatsoever.

TITLE OF GOODS

Title in the goods remains with the seller until full payment has been received by the company.

a) Should the buyer default in any payment when due, the seller will be entitled to repossess all the goods held by the buyer which are still the sellers property (without prejudice to any other right or remedy arising out of such default in payment) and for this purpose the seller will be entitled to enter upon the land or buildings on or which the goods may be situated and to remove the same. All costs incurred by the seller in repossessing the goods shall be borne by the buyer.

b) Any goods so repossessed shall be sold and the proceeds of the sale set off against the amounts due to the seller by the buyer. Any balance remaining of the proceeds of sale shall be paid to the buyer. If the said proceeds of sale are not sufficient the buyer shall remain liable to pay to the seller the amount remaining due together with any interest accruing therein.

DEFINITIONS

THE SELLER:

Refers to Tacit

THE BUYER:

The organisation/person purchasing the goods.

Please note Tacit has a policy of continual improvement, therefore we have to advise that sizes, weights, measurements and colours shown in the catalogue are nominal only and changes to designs, specifications and equipment may occur at any time without notice and without incurring any obligations. The precise specification of any article will always be given, if requested, on application.

N.B: All photographs, company names, golf courses and logos appearing in this brochure are for illustration purposes only and do not infer endorsement.



WWW.TACITGOLF.COM

EMAIL: sales@tacitgolf.com | **TEL:** +44 (0)1788 568818